

library furniture

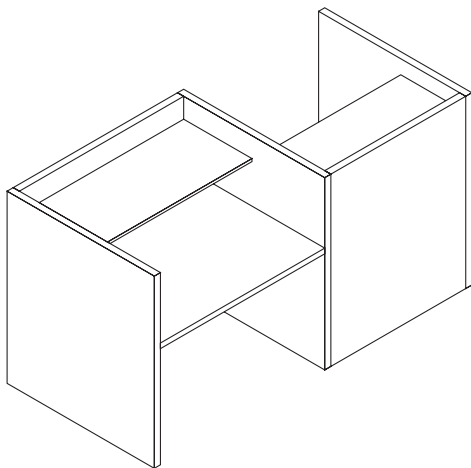
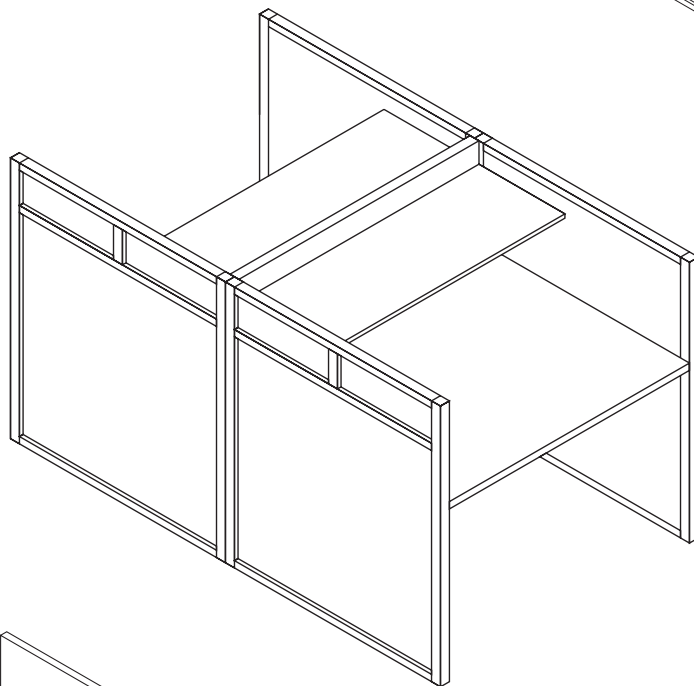
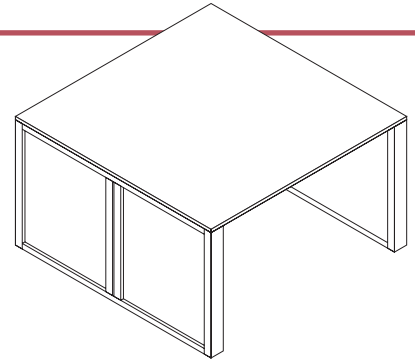

Information for Ordering2

Product Information 3 – 4

Condition of Sale 4 – 5

Furniture Quote Information6

How to Specify7

Shelving

- Modular Shelving9
- Free-Standing Shelving.....10
- Shelving Accessories11 – 12

Canopy Tops

- Canopy Edge Details13

Style Overview14 – 15

Universal LT

- End Panels.....18 – 19
- Reading Tables.....20
- Study Tables.....21
- Carrels22 – 23
- Accessories24

Universal

- End Panels.....26 – 27
- Reading Tables.....28
- Study Tables.....29
- Carrels30 – 31
- Accessories32

Pacific

- End Panels.....34 – 35
- Reading Tables.....36
- Study Tables.....37
- Carrels38 – 39
- Accessories40

Mountain

- End Panels.....42 – 43
- Reading Tables.....44
- Study Tables.....45
- Carrels46 – 47
- Accessories48

Desert

- Reading Tables.....50
- Study Tables.....51

Baron

- Reading Tables.....54
- Study Tables.....55

Ridge

- End Panels.....58 – 59
- Carrels60 – 61
- Accessories62

Occasional / Game Tables.....63

Computer Units.....65

Circulation Desks

- Modular Components.....66 – 67
- Circulation Desk Accessories68 – 69

Options70 – 71

Dock Delivery Price List.....72

Literature Request Form.....73

arnoldkolax

Arnold Kolax Furniture, Inc.

Manufacturer: Arnold Kolax Furniture, Inc. • 609 Chancellor Avenue, Irvington, NJ 07111
 Tel 973-375-3344 • Fax 973-375-6024 • Toll Free 866-425-6529
 www.arnoldkolax.com • info@arnoldkolax.com

General Information for Ordering:

1. **Point of Production:** Irvington, NJ (Essex County)
2. **Time of Delivery:** Approximately 8 weeks
3. **Expedited Delivery:** Some items in this catalog are available for expedited delivery. Call factory for information.
4. **Overnight and 2-day Delivery:** Not available.
5. **F.O.B. Point:** Irvington, New Jersey, Essex County
6. **Ordering Address:** Arnold Kolax Furniture, Inc., 609 Chancellor Avenue, Irvington, New Jersey 07111
7. **Payment Address:** Arnold Kolax Furniture, Inc., 609 Chancellor Avenue, Irvington, New Jersey 07111
8. **Terms and Conditions of Rental, Maintenance and Repair:** Call Factory
9. **Terms and Conditions of Installation:** Call Factory
10. **Terms and Conditions of Repair Parts:** Call Factory
11. **Service and Distribution Points:** Contact your local Arnold Kolax Furniture, Inc. representative for current listing of service and distribution points.
12. **List of Participating Dealers:** Contact your local Arnold Kolax Furniture, Inc. representative for current listing of authorized dealers in your area.
13. **Preventative Maintenance:** Contact factory for pamphlet.

Product Information:

- 1. Woods/ Veneers:** All solid woods and veneers used on exterior surfaces are #A select grades. Plain sliced *American Walnut*, *White Oak*, *Maple*, and *Cherry*, applied in a “reverse slip match” fashion resulting in a balanced appearance, as well as slip match *Sapele* (*Mahogany*), are the standard veneers used. *Anigre* veneers are available at an upcharge. Every effort is made to match solid wood and veneer of like color and grain, however, since wood is a natural material, some variation in grain, color, and character may occur. This variation is not considered a defect.

Arnold wood sample color chips are dated, and only chips dated with the current year should be used. If older samples are used, please send the sample used with the purchase order for proper color adjustment.
- 2. About Woods:** Arnold Kolax Furniture would like to take this opportunity to point out to its customers several of the distinguishing characteristics that make wood such a unique material with beauty and charm:

 - No two trees are exactly alike, and as a result, natural variations in color and tone are to be expected.
 - Solid woods and veneers accept stain in varying degrees, thereby contributing to slight differences in shading.
 - Woods are highly susceptible to color changes from exposure to light, particularly from the ultraviolet rays. *Cherry* is extremely photo sensitive. It is recommended that the end user be instructed to avoid placing wood products in areas with prolonged exposure to direct sunlight. This will help to minimize, though not eliminate, color changes.
 - Properly maintained levels of humidity in the environment where the furniture is placed should also minimize instances of warping, checking, and cracking of veneers and solids. Fluctuations in humidity and temperature may cause panels and solid wood components to expand and contract, and may lead to panel warpage and finish checking or cracking. Prolonged exposure of furniture to dry heat during winter months should be avoided.

A minimum humidity level of 45% in climate controlled buildings is very important for the proper care of natural wood products.

Note: Due to the nature of *Burl* and *Crotch* veneers, the temperature and humidity of the environment into which the product is placed may cause changes to the face veneer. Arnold cannot be held responsible for checking and/or shrinkage that may occur over the course of time.
- 3. Wood Finishes:** Arnold Kolax Furniture offers a substantial number of different stains on *White Oak*, *Walnut*, *Sapele* (*Mahogany*), *Cherry*, *Anigre* and *White Maple* solid woods and veneers. A “seven step” open pore finish is standard. It is a rich, lustrous, water and alcohol resistant, 40° satin sheen, multi-coat pre-catalized top coating applied over a “hand rubbed” wiping stain. Color consistency is maintained by constant comparisons to “control panels” at every step in the finishing process.
- 4. Special Wood Finishes:** Arnold Kolax Furniture, Inc. provides its customers finish matching capability. Customer must submit a 3" x 3" sample of the finish to be matched.

The amount of upcharge is based on the following criteria:

 - \$82.50 minimum on any special wood finish.
 - Color matching only of samples with open or closed pore finish: +15%
 - Color and texture match of closed pore finishes: + 25%
 - Closed pore finish (top surface only) on any Arnold standard wood stain: + 10%
 - Buffed/polished appearance: call factory.
 - Finish matching requiring bleaching will result in an additional charge. The factory reserves the right to make the final determination.
- 5. Plastic Laminates:** Arnold Kolax Furniture offers both complete plastic laminate products and wood products with plastic laminate tops. In addition to the above, most products offered by Arnold Kolax Furniture are also available with laminate tops, at no additional charge, in any color or texture of your choice from *Pionite*, *Nevamar*, *Formica*, or *Wilsonart*.
- 6. Natural Stones:** Marble and granite tops are available on selected Arnold Kolax Furniture products. They can be either inlaid or overlaid (no wood edge). Please refer to the individual product sections to determine which products are available with stone tops.

Please note that not all granites are available on any given product; consult the introductory pages at the beginning of each section for availability.

Product Information (cont'd.):

7. Finishes:

Wood Finish*

Wood is a natural material and some variation in color grain and character may occur. This variation is not considered a defect.

Walnut:	#101 Royal Walnut	#105 Cappuccino Walnut
	#102 Cordovan Walnut	#106 Natural Walnut
	#104 Senator Walnut	#503 Ebonized Walnut

Oak:	#200 Natural Oak	#501 Ebonized Oak
	#201 Harvest Oak	

Mahogany:	#300 Mahogany	#303 Scarlet Mahogany
	#301 Cherry Mahogany	

Cherry:	#400 Medium Cherry	#404 Red Cherry
	#401 Light Cherry	#406 Classic Cherry
	#402 Victorian Cherry	#408 English Cherry

Maple:	#700 Natural White Maple
	#701 Pearwood on Maple

Anigre:	#603 Light Anigre (available at an upcharge)
----------------	--

Solid Color:	#900 White	#904 Earth
	#901 Black	#905 Tangerine
	#902 Graphite	#906 Lime
	#903 Smoke Gray	#907 Misty Gray

Please call factory for custom finish and/or stone availability.

When placing orders for products made by two or more Arnold Companies that are to be used in the same area, please indicate "finish together" on your purchase order, and verify our acknowledgement of this requirement.

Natural Stone***

Marble and granite are natural materials and so some variations in pattern and color will exist within each slab, as well as from piece to piece.

Marble:

- White Calacatta Gold (White)
- Jerusalem Gold Limestone (Gold)
- Light Emperador (Lt. Brown)
- Verde Oriental (Green)
- Rosso Levanto (Red)
- Dark Emperador (Dk. Brown)
- Botticino Semi-Classico (Beige)
- White Carrara (White)
- Crystal Salome (Gray/Burgundy)
- Negro Marquina (Black)
- Rosa Aurora (Rose/White)
- Spring Green (Green)

Granite:

- Dakota Mahogany (Red/Black)
- Ubatuba (Gold/Black)
- Blue Pearl (Black/Gray)
- Impala Black (Black/Gray)
- Black Galaxy (Black)
- Absolute Black (Black)
- Luna Pearl (Salt/Pepper)
- Rosa Porrina (Rose/Gray)

8. Special and Custom Items:

Arnold Kolax Furniture has the ability, through its flexible manufacturing policy, to produce custom library furniture, or modify any existing Arnold line to meet the user's requirements. Please submit your plans and specifications for a quotation. All sales on custom or specially modified items are final. A 50% deposit is required when the order is placed, whether or not credit is established with Arnold. These orders cannot be cancelled once the manufacturing process has started.

9. Options/ Accessories:

A variety of product options are available from Arnold Kolax Furniture including such value added items as refrigerators, computer support peripherals and a variety of Power, Data, and Voice grommets that allow the user to connect and conceal CRT and CPU hardware. The compatibility of individual options is noted on each page; a more detailed description of the option is at the back of the book.

10. GSA

Arnold Kolax Furniture has been awarded several GSA (Government Services Administration) federal and state contracts. GSA price listed and state contract details and procedures are available on request and at our website.

Condition of Sale:

1. Terms:

Net 30 days. All prices shown in this price list are list prices, FOB our factory Irvington, New Jersey. Prices are effective January 1, 2009 and are valid until superceded. This price list supercedes all previous Arnold Kolax Furniture price lists.

Ordering Information — Order directly by mail, fax, telephone or email to Arnold Kolax Furniture as indicated on page 2 in this price list. Orders for merchandise from more than one Arnold Company may be sent to any one of the companies. Telephone orders must be confirmed by a purchase order. Duplicate orders received not marked "Confirmation" are the responsibility of the buyer.

2. New Accounts:

Please include three satisfactory credit references, one bank reference, and a 50% deposit with your first order.

3. Acknowledgements:

Upon credit approval, all orders will be acknowledged by Arnold Kolax Furniture. Acknowledgements indicate terms of sale, discount rate, buyer's representative, transportation company, approximate shipping date, merchandise ordered, freight cost if applicable, and our acknowledgement number. All prices are FOB factory, blanket wrapped, unless otherwise indicated. Please check the acknowledgement for accuracy, and call Arnold Kolax Furniture immediately in case of a question or discrepancy. Arnold Kolax Furniture will not be held responsible on orders placed on the phone without written confirmation.

Condition of Sale (cont'd.):

4. **Prices:** Prices are based on an order as written, and not necessarily on your inquiry or our original quotation. The prices as shown on the acknowledgment are final and will be invoiced on the date of shipment.
5. **Cancellation and/or Changes:** Orders are processed immediately upon receipt, and cancellations or changes can only be made with prior approval of Arnold Kolax Furniture. A cancellation charge of 10% will be incurred after a period of three working days. Cancellation of "Work in Progress" is subject to a 25% charge. Special orders, special finishes, "Quick Ship," and orders marked "Rush" cannot be cancelled. Cancellation of a standard unit after fabrication will incur a 50% charge.
6. **Shipping Delays:** Diligent effort will be made to ship orders for the date acknowledged. We cannot be held financially responsible for delays due to strikes, accidents, raw material shortages or other delays.
7. **Packing & Shipping:** Goods are carefully inspected and blanket wrapped or cartoned before being turned over to the transportation company.
8. **Damaged Material:** The goods are carefully inspected and in good condition when accepted by the carrier. If damage occurs, it is your responsibility to immediately notify the transportation company to make an inspection prior to discarding packaging material. If the packaging material is damaged, you must make this request upon receipt of the shipment. If the damage is concealed, you must make this request when the material is unpacked and save the packing materials.
9. **Manufacturing Defects:** Claims of a factory defect must be verified by a factory representative. Unauthorized deductions from our invoice will not be allowed.
10. **Generalities:** All Arnold Kolax Furniture products (if applicable) are shipped with heavy duty 1/4-20 tread adjustable nylon glides that permit perfect drawer and door alignment. A strip of wood (a skid strip) protecting the product during shipment must be removed before the glides can be adjusted to meet the contours of the floor. Multi-piece table tops are shipped with "level tights," that allow for perfectly flush alignment of tops.
11. **Product Changes:** Arnold Kolax Furniture reserves the right to make changes in design and construction or to discontinue products without prior notice.
12. **Warranty:**

Arnold Kolax Furniture warrants to its initial customers that its products conform to specifications, drawings, samples, or other product descriptions furnished by Arnold Kolax Furniture, and are of good material and workmanship, free of manufacturing and factory defects, and will function properly under normal use and service for five years if installed by Arnold Kolax Furniture or an authorized Arnold dealer. However, natural variations in color and grain patterns occur in bent wood, solid wood, and veneers.

The warranty set forth above does not apply to products modified, altered, or repaired by unauthorized personnel, or to products damaged during shipment or installation, or by accident, abuse, alteration, misuse, tampering, misapplication, negligence by others, improper repair or maintenance, fire and/or other casualty. This warranty does not apply to defects in components not manufactured by Arnold Kolax Furniture.

It is expressly understood and agreed that the customer's sole and exclusive remedy for any and all losses or damages resulting from non-conforming goods, or from any other causes, shall be the repair or replacement of defective parts at the option of Arnold Kolax Furniture, and that Arnold Kolax Furniture shall not be liable for damages, for injury to persons or property, nor for replacement of the entire commercial unit, if repair or replacement of defective parts can reasonably render the unit conforming.

SELLER MAKES NO OTHER WARRANTIES, EITHER EXPRESSED OR IMPLIED, AS TO ANY MATTER WHATSOEVER, AND ARNOLD KOLAX FURNITURE DISCLAIMS ANY WARRANTY OF MERCHANTABILITY OR FITNESS FOR A PARTICULAR USE OR PURPOSE.

No officer, employee, or representative of Arnold Kolax Furniture has the authority to assume greater liability than that described above.

Furniture Quote Information

Date: _____

When requesting a furniture quote, please provide Arnold Kolax Furniture the following information:

General Information

- Dealer Name _____
- Dealer Location _____
- Dealer Phone/Fax _____
- Project Name/Location _____

Freight Information

- Freight Address _____
- Dock Delivery/ Inside Delivery (Freight Elevator) _____

Product Information

- Furniture Info _____
- Style # _____
- Color Finish _____
- Edge Detail _____
- Special Dimension Requirements _____
- Special Instructions _____

Example:

Dealer Name: John Smith / Smith Interiors

Dealer Location: 123 Main St., Anywhere, NY 10000

Phone/Fax/Email: (p) 555-555-1234 (f) 555-555-9876

Project Name/Location: Sunshine Library, Manhattan, New York

Freight Address: Shipping to Farmingdale, NY 11735 Inside Delivery (Freight Elevator)

Furniture Info: Single-Faced Adder Carrel with Full End Panel & Round Table

Style #: GLMFCA-36 & GLRT-48

Color Finish: Mahogany #300 (Carrel) & Custom Maple (Round Table)

Edge Detail: Universal Edge (Style B)

For assistance in preparing your quote request, please contact the office @ 973.375.3344

How to Specify

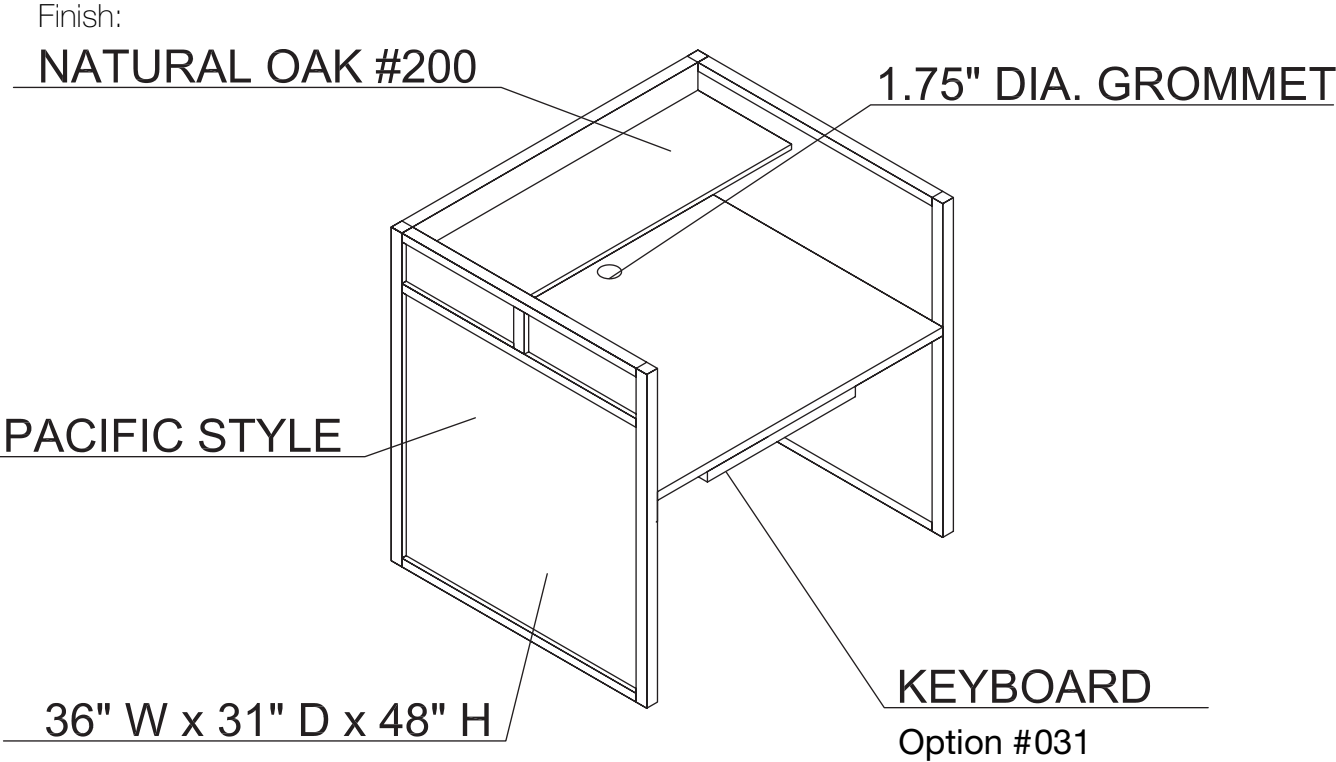

Modular Shelving

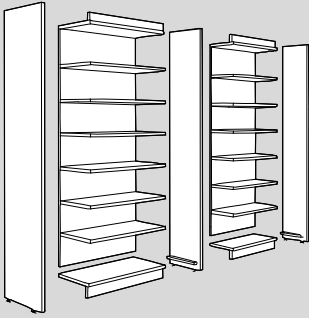

Specifying Modular Library Shelving:

Each Single-Sided or Double-Sided Add-On Unit consists of one left side panel (1" thick), one back 28.5" or 34.5" wide, a top, bottom, and shelves. In a run, a partition is substituted for the right end panel until the run is complete; only then should an End Panel LSAX or LSDX be specified.



Example:



GLSAX
1" thick
End
Panel

Total length of run 131" wide: (34.5 x 2 = 69") + (28.5" x 2 = 57") + 5 uprights = 131"

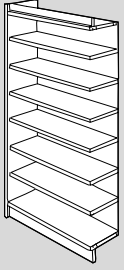
SINGLE & DOUBLE SIDED

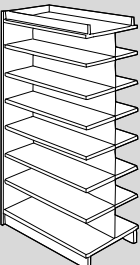
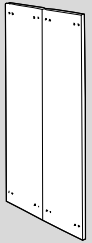
	Width	Ht.	Shelves	Style Number	List Price	Ship Wt.	Options (See back of book)
 <p>Single-Sided Add-On Unit</p> <ul style="list-style-type: none"> • 10.375" deep 	29.5" W	42"	2	GLSA42-30-__	\$777	55	G80 - 12" deep units +10% G88 - 15" deep units +20% G89 - 108" high +15% to 96" high price.
		60"	3	GLSA60-30-__	873	70	
		72"	4	GLSA72-30-__	970	75	
		84"	5	GLSA84-30-__	1067	80	
	96"	6	GLSA96-30-__	1143	85		
	35.5" W	42"	2	GLSA42-36-__	804	65	
		60"	3	GLSA60-36-__	899	80	
		72"	4	GLSA72-36-__	998	85	
		84"	5	GLSA84-36-__	1095	90	
		96"	6	GLSA96-36-__	1191	95	
 <p>End Panel for Single-Sided Add-On Unit</p> <ul style="list-style-type: none"> • 1" thick 		10.375" W	42"		GLSAX-42-__	140	65
	60"			GLSAX-60-__	162	80	
	72"			GLSAX-72-__	183	85	
	84"			GLSAX-84-__	199	90	
	96"			GLSAX-96-__	219	95	
 <p>Double-Sided Add-On Unit</p> <ul style="list-style-type: none"> • 19.5" deep 	29.5" W	42"	4	GLSD42-30-__	1485	70	G81 - 22.75" deep + 10% G89 - 108" high +15% to 96" high price.
		60"	6	GLSD60-30-__	1613	90	
		72"	8	GLSD72-30-__	1724	110	
		84"	10	GLSD84-30-__	1892	130	
	96"	12	GLSD96-30-__	1999	160		
	35.5" W	42"	4	GLSD42-36-__	1539	85	
		60"	6	GLSD60-36-__	1668	110	
		72"	8	GLSD72-36-__	1781	130	
		84"	10	GLSD84-36-__	1948	150	
		96"	12	GLSD96-36-__	2060	170	
 <p>End Panel for Double Sided Add-On Unit</p> <ul style="list-style-type: none"> • 1" thick 		19.5" W	42"		GLSDX-42-__	279	40
	60"			GLSDX-60-__	323	50	
	72"			GLSDX-72-__	365	60	
	84"			GLSDX-84-__	405	70	
	96"			GLSDX-96-__	438	80	

Free-Standing Shelving

FREE-STANDING

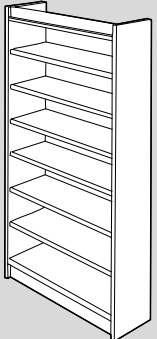
		Width	Ht.	Shelves	Style Number	List Price	Ship Wt.	Options (See back of book)
 <p>Free-Standing Shelving Unit</p> <ul style="list-style-type: none"> • 10.375" deep 	30.5" W	42"	2	GLSF42-30-__	\$917	70	G80 - 12" deep units +10% G88 - 15" deep units +20% G89 - 108" high +15% to 96" high price.	
		60"	3	GLSF60-30-__	1035	90		
		72"	4	GLSF72-30-__	1153	95		
		84"	5	GLSF84-30-__	1266	110		
		96"	6	GLSF96-30-__	1362	120		
		96"	6	GLSF96-30-__	1362	120		
	35.5" W	42"	2	GLSF42-36-__	944	80		
		60"	3	GLSF60-36-__	1061	100		
		72"	4	GLSF72-36-__	1181	110		
		84"	5	GLSF84-36-__	1294	120		
		96"	6	GLSF96-36-__	1410	130		
		96"	6	GLSF96-36-__	1410	130		

SHELVING ACCESSORIES

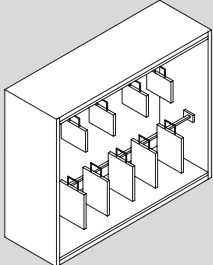
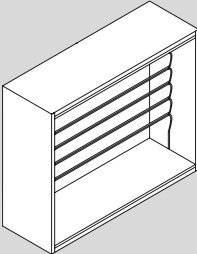
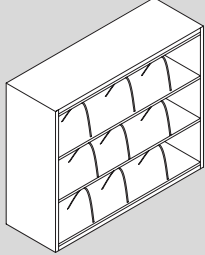
		Width	Style Number	Bookcase Height	List Price	Ship Wt.	Options (See back of book)
 <p>Hanging Bag Rack</p> <p>*Price is for hanging rod and bags only.</p>	28.5" wide	GLHBR-30		\$358	15		
	34.5" wide	GLHBR-36		386	17		
 <p>Newspaper Rod Insert</p> <p>*Price is for rod inserts only.</p>	28.5" wide	GLNRI-30		119	12		
	34.5" wide	GLNRI-36		133	15		
 <p>Metal Picture Book Shelving</p> <p>*Price is for metal picture book shelves only.</p>	28.5" wide	GLMPB-30		77	12		G84 - Black wire dividers + \$17. each
	34.5" wide	GLMPB-36		83	15		

Shelving Accessories

SHELVES

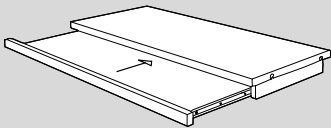
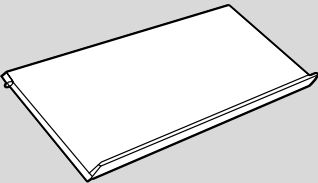
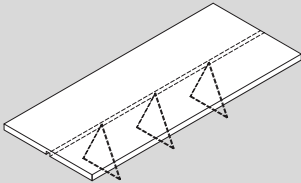
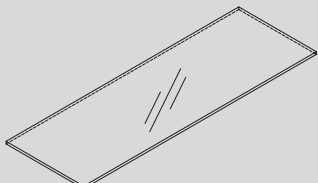
		Width	Style Number	Bookcase Height	List Price	Ship Wt.	Options (See back of book)
 <p>Pull-out Reference Shelf</p> <ul style="list-style-type: none"> For 12" deep LSA and 22.75" deep LSD units only. 	28.5" wide	GLREF-30		\$358	15		
	34.5" wide	GLREF-36		386	17		
 <p>Periodical Shelf</p> <ul style="list-style-type: none"> Lip 1.5" 	28.5" wide	GLPS-30		119	12		
	34.5" wide	GLPS-36		133	15		
 <p>Shelf Grooved for Dividers</p>	28.5" wide	GLDS-30		77	12	G84 - Black wire dividers + \$17 each	
	34.5" wide	GLDS-36		83	15		
 <p>Glass Shelf</p> <ul style="list-style-type: none"> 1/4" thick clear glass 	28.5" wide	GLGS-30		72	12		
	34.5" wide	GLGS-36		79	15		

Shelving Accessories

DOORS

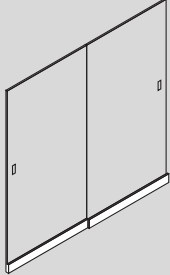
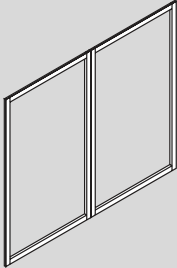
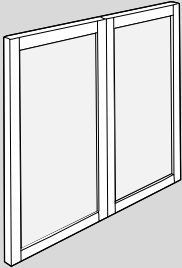
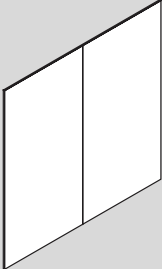
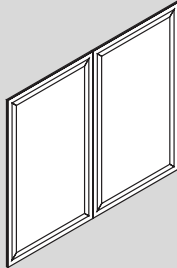
			Style Number	Bookcase Height	List Price	Ship Wt.	Options (See back of book)	
<p>Glass Doors for Shelving</p> <p>.25" thick clear glass</p> <p>Prices are per pair, for 30" and 36" wide units only.</p> <p>Units wider than 36" require two sets of doors.</p>		<p>Sliding Glass Doors</p>	GGSD-29	29"	\$504	30	<p>G54 - Sliding glass door lock + \$65</p>	
			GGSD-36	36"	537	35		
			GGSD-42	42"	569	40		
			GGSD-48	48"	635	45		
			GGSD-60	60"	727	50		
			GGSD-72	72"	1075	70		
			GGSD-84	84"	1140	80		
			GGSD-96	96"	1271	90		
		<p>Hinged Metal Frame Glass Doors</p>	GMDHD-29	29"	513	25	<ul style="list-style-type: none"> • Specify clear or acid etched glass • For handle options, please consult factory 	
			GMDHD-36	36"	525	30		
			GMDHD-42	42"	575	35		
			GMDHD-48	48"	622	40		
			GMDHD-60	60"	678	45		
			GMDHD-72	72"	737	60		
			GMDHD-84	84"	905	70		
			GMDHD-96	96"	970	80		
		<p>Hinged Glass Doors</p> <ul style="list-style-type: none"> • With 2.25" solid wood frame on four sides. 	GGFFD-29	29"	700	30	<p>010 - Hinged door lock + \$66 per pair of doors</p> <p>For more option information, see back of book.</p>	
			GGFFD-36	36"	748	35		
			GGFFD-42	42"	796	40		
			GGFFD-48	48"	985	45		
			GGFFD-60	60"	1045	50		
			GGFFD-72	72"	1104	70		
			GGFFD-84	84"	1591	80		
			GGFFD-96	96"	1663	90		
<p>Wood Doors for Shelving</p> <p>Prices are per pair, for 30" and 36" wide units only.</p> <p>Units wider than 36" require two sets of doors.</p>		<p>Hinged Straight Grain Wood Doors</p> <ul style="list-style-type: none"> • .75" thick 	GPHD-29	29"	356	30		
			GPHD-36	36"	386	35		
			GPHD-42	42"	415	40		
			GPHD-48	48"	463	45		
			GPHD-60	60"	499	50		
			GPHD-72	72"	558	70		
			GPHD-84	84"	618	80		
			GPHD-96	96"	688	90		
		<p>Hinged Raised Panel Wood Doors</p> <ul style="list-style-type: none"> • Square frame; solid wood raised panel insert. 	GRPD-29	29"	534	30		
			GRPD-36	36"	588	35		
			GRPD-42	42"	653	40		
			GRPD-48	48"	843	45		
			GRPD-60	60"	903	50		
			GRPD-72	72"	974	70		
			GRPD-84	84"	1304	80		
			GRPD-96	96"	1425	90		

- Glass doors and raised panel doors 48", 60" and 72" high have a center wood rail.
- Shelving 72" high and over have two sets of doors.
- Units wider than 36" require two sets of doors.

Canopy Edge Details

For Canopy only
Specify Edge Detail:
A, C, E, L, M, S or U



A - 1.25" Bullnose



B - 2" Bullnose



C - 1.25" Bevel



D - 2" Bevel



S - 1.25" Transitional



E - 2" Traditional



T - 1.25" Traditional



L - 2" Duet



U - 1.25" Universal



M - 2" Reeded

Note:

- 1. All tops longer than 96" will be 2 or more pieces.
- 2. For cornice tops, crown molding options and lighting, please consult factory.

*For additional edge options, please consult factory.

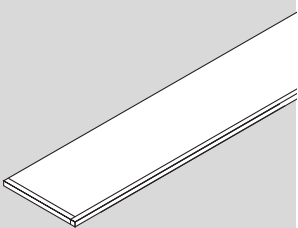
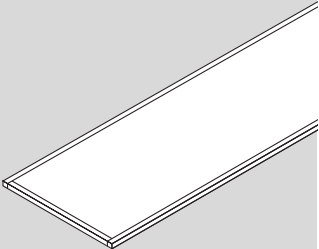
		Width	Style Number 1.25" / 2"	1.25" List Price/Ft.	2" List Price/Ft.
 <p>Single-Sided</p> <ul style="list-style-type: none"> • 1-1/4" or 2" thick • Solid wood edge 	8"	GLCT-8-__	\$70	\$92	
	10"	GLCT-10-__	74	96	
	12"	GLCT-12-__	78	100	
	15"	GLCT-15-__	82	104	
	16"	GLCT-16-__	86	108	
 <p>Double-Sided</p> <ul style="list-style-type: none"> • 1-1/4" or 2" thick • Solid wood edge 	20"	GLCT-20-__	106	128	
	24"	GLCT-24-__	114	136	
	30"	GLCT-30-__	122	144	

Style Overview

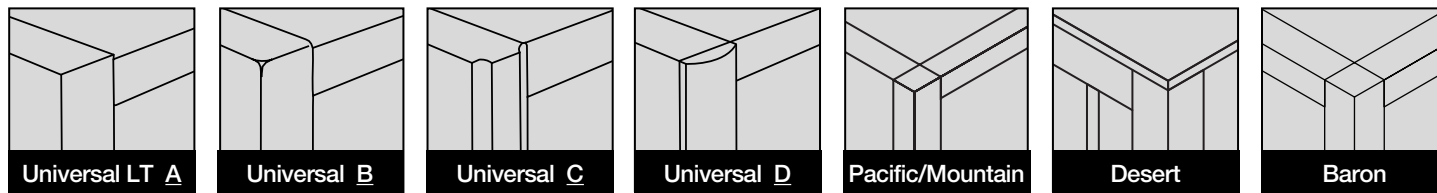

The **Universal Series** is available with the following edge details

Style A – our standard veneered self edges

Style B – 1/4" solid wood banding with radius edges

Style C – 1/4" solid wood banding with concave edges

Style D – 1/4" wood banding with flat bullnose edges

The **Pacific & Mountain Series** features 3/4" veneer panels with 1-1/4" solid wood border. The panels are accented with 1/2" thick applied solid woods.

Study Carrels are shipped K.D. unless set-up is specifically requested. K.D. fittings are attached to modular connectors that are fully concealed in the panels. Locked in position, they ensure a secure joint between side and back panels. Carrels are constructed of 1.25" material with solid edge banding on all exposed edges. Back is 1.25" thick; upper shelf is .75" thick with 2" fascia. One grommet is standard on worksurface. Tops can be wood, or laminate on request. VDT Integrated Monitor System packages are available on all standard sizes.

Raised Panel Carrels have 1" x 3" vertical stiles and 1" x 4" horizontal rails. The 3/4" solid raised panels are grooved into the rails and stiles. Back panels and partitions have the same frame construction, however, 1/4" flat panels are grooved into the stiles and rails.

Reading and Index Tables are available in juvenile height (27") and adult height (29"). 1.25" thick tops are available in wood or laminate at the same price. Particle board core is standard; lumbercore is available as an option at an upcharge. Legs are constructed of 2.25" solid wood. Index Tables have the same construction as the Reading Tables, and are available in the same heights. Index Tables provide more privacy to the user with .75" thick partitions; the number of partitions varies with the size of the table top.

Circulation Desk Components are all constructed with .75" thick particle board. The tops are 1.25" thick with a 2" overhang on the approach side, and a 1.75" overhang on the working side. The 3" high toekick is recessed 2". Components can be set up in any configuration that meets your requirements.

Mobile Units are constructed of 1" particle board. All units, except the computer utility tables, are equipped with four dual casters. 4" metal crescent pulls are standard on all units with doors. Locks are optional. All units have outside finished backs.

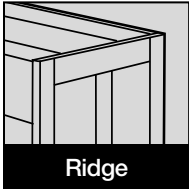

Arnold Kolax Library Furniture

Arnold Kolax library furniture is available in several designs. Edge details for all Arnold Kolax Furniture lines are illustrated here.

Dictionary and Atlas Stands are constructed of 1.25" material with solid edgebanding on all exposed edges. They are permanently assembled and glued with doweled construction. Newspaper Racks have ten wooden display rods.

Low voltage halogen lights are available as an accessory. These lights remain cool during operation and minimize UV rays. They have a longer life span and a higher efficiency than standard incandescent lights. The halogen lights are 10 watts each, and are supplied with high quality reflectors and glass lenses. Black rings are standard, but the decorative rings are also available in a variety of colors on special request. For additional lighting options, please consult factory.

Options:

Listed in the right hand column of each page are a variety of options available for each product. These options are applicable only to the product with which they are associated. A more detailed description of all of the options listed are shown on pages 68 – 69.

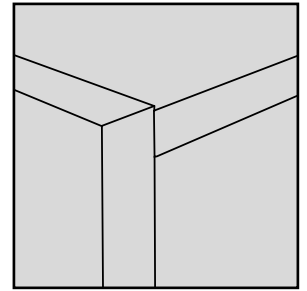

Universal LT

End Panels

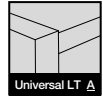

SINGLE-SIDED END PANELS

	Width	Ht.	Style Number	List Price	Options (see back of book)
 <p>Single-Sided End Panel</p> <ul style="list-style-type: none"> • 1" thick 	8" W	30"	GLSAX-308-A	\$110	G89 – 108" high +15% to 90" high price
		36"	GLSAX-368-A	118	
		42"	GLSAX-428-A	128	
		48"	GLSAX-488-A	139	
		60"	GLSAX-608-A	148	
		66"	GLSAX-668-A	158	
		72"	GLSAX-728-A	167	
		84"	GLSAX-848-A	182	
		90"	GLSAX-908-A	200	
	10" W	30"	GLSAX-3010-A	122	
		36"	GLSAX-3610-A	131	
		42"	GLSAX-4210-A	142	
		48"	GLSAX-4810-A	154	
		60"	GLSAX-6010-A	164	
		66"	GLSAX-6610-A	175	
		72"	GLSAX-7210-A	186	
		84"	GLSAX-8410-A	202	
		90"	GLSAX-9010-A	222	
	12" W	30"	GLSAX-3012-A	134	
		36"	GLSAX-3612-A	144	
		42"	GLSAX-4212-A	156	
		48"	GLSAX-4812-A	170	
		60"	GLSAX-6012-A	181	
		66"	GLSAX-6612-A	193	
		72"	GLSAX-7212-A	204	
		84"	GLSAX-8412-A	222	
		90"	GLSAX-9012-A	245	
	15" W	30"	GLSAX-3015-A	147	
		36"	GLSAX-3615-A	158	
		42"	GLSAX-4215-A	170	
		48"	GLSAX-4815-A	185	
		60"	GLSAX-6015-A	197	
		66"	GLSAX-6615-A	210	
		72"	GLSAX-7215-A	223	
		84"	GLSAX-8415-A	242	
		90"	GLSAX-9015-A	267	
16" W	30"	GLSAX-3016-A	150		
	36"	GLSAX-3616-A	162		
	42"	GLSAX-4216-A	175		
	48"	GLSAX-4816-A	190		
	60"	GLSAX-6016-A	202		
	66"	GLSAX-6616-A	216		
	72"	GLSAX-7216-A	229		
	84"	GLSAX-8416-A	249		
	90"	GLSAX-9016-A	274		

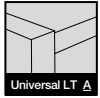

End Panels

DOUBLE-SIDED END PANELS

	Width	Ht.	Style Number	List Price	Options (see back of book)
 <p>Double-Sided End Panel</p> <ul style="list-style-type: none"> • 1" thick 	20" W	30"	GLSDX-3020-A	\$258	G89 – 108" high +15% to 90" high price
		36"	GLSDX-3620-A	267	
		42"	GLSDX-4220-A	283	
		48"	GLSDX-4820-A	306	
		60"	GLSDX-6020-A	328	
		66"	GLSDX-6620-A	350	
		72"	GLSDX-7220-A	371	
		84"	GLSDX-8420-A	412	
		90"	GLSDX-9020-A	445	
	24" W	30"	GLSDX-3024-A	284	
		36"	GLSDX-3624-A	294	
		42"	GLSDX-4224-A	312	
		48"	GLSDX-4824-A	336	
		60"	GLSDX-6024-A	361	
		66"	GLSDX-6624-A	385	
		72"	GLSDX-7224-A	408	
		84"	GLSDX-8424-A	453	
		90"	GLSDX-9024-A	490	
	30" W	30"	GLSDX-3030-A	322	
		36"	GLSDX-3630-A	334	
		42"	GLSDX-4230-A	354	
		48"	GLSDX-4830-A	382	
		60"	GLSDX-6030-A	410	
		66"	GLSDX-6630-A	437	
		72"	GLSDX-7230-A	464	
		84"	GLSDX-8430-A	515	
		90"	GLSDX-9030-A	557	

Reading Tables

Please specify child 27" or adult 29".
 Example: Child: GLRT-4230-27-A
 Adult: GLRT-7242-29-A

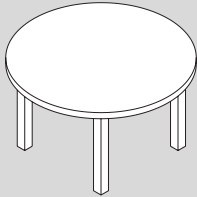
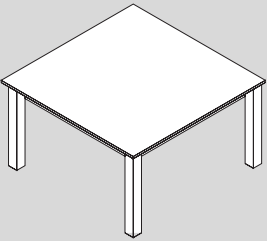
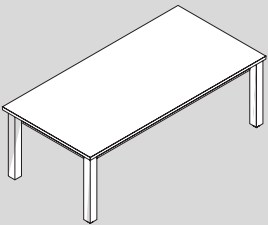

		Top Size (w x d)	Height	Style Number	List Price
	Round Reading Table	36" dia.		GLRT-36-__-A	\$1,289
		42" dia.		GLRT-42-__-A	1,361
		48" dia.	Please specify child 27" or adult 29"	GLRT-48-__-A	1,431
		54" dia.		GLRT-54-__-A	2,333
		60" dia.		GLRT-60-__-A	2,800
		72" dia.		GLRT-72-__-A	3,694
	Square Reading Table • 3" high apron	36" x 36"		GLRT-3636-__-A	1,049
		42" x 42"	Please specify child 27" or adult 29"	GLRT-4242-__-A	1,118
		48" x 48"		GLRT-4848-__-A	1,392
		54" x 54"		GLRT-5454-__-A	1,922
		60" x 60"		GLRT-6060-__-A	2,527
	Rectangular Reading Table • 3" high apron	42" x 24"		GLRT-4224-__-A	939
		48" x 24"	Please specify child 27" or adult 29"	GLRT-4824-__-A	1,076
		54" x 24"		GLRT-5424-__-A	1,095
		60" x 24"		GLRT-6024-__-A	1,120
		72" x 24"		GLRT-7224-__-A	1,192
		84" x 24"		GLRT-8424-__-A	1,316
		42" x 30"		GLRT-4230-__-A	980
		48" x 30"		GLRT-4830-__-A	1,117
		54" x 30"		GLRT-5430-__-A	1,136
		60" x 30"		GLRT-6030-__-A	1,161
		72" x 30"		GLRT-7230-__-A	1,233
		84" x 30"		GLRT-8430-__-A	1,357
		96" x 30"		GLRT-9630-__-A	1,481
		42" x 36"		GLRT-4236-__-A	1,062
		48" x 36"		GLRT-4836-__-A	1,198
		54" x 36"		GLRT-5436-__-A	1,219
		60" x 36"		GLRT-6036-__-A	1,244
		72" x 36"		GLRT-7236-__-A	1,335
		84" x 36"		GLRT-8436-__-A	1,419
		96" x 36"		GLRT-9636-__-A	1,543
		48" x 42"		GLRT-4842-__-A	1,609
		54" x 42"		GLRT-5442-__-A	1,630
		60" x 42"		GLRT-6042-__-A	1,711
72" x 42"		GLRT-7242-__-A	1,795		
84" x 42"		GLRT-8442-__-A	1,928		
96" x 42"		GLRT-9642-__-A	2,120		



Please specify child 27" or adult 29".
 Example: Child: GLRT-4230-27-A
 Adult: GLRT-7242-29-A

Study Tables

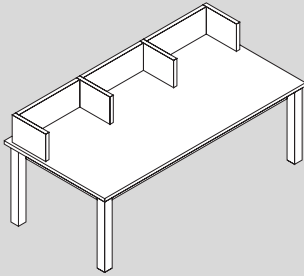
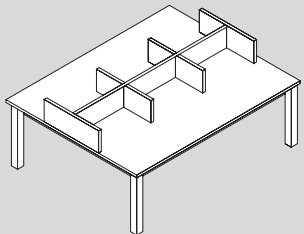
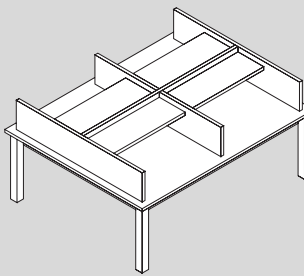
	Top Size (w x d)	Height	Style Number	List Price
 <p>PAC Table Single-Sided, Single Tier</p> <ul style="list-style-type: none"> • 60 and 72" wide tables have 2 sections. • 96" wide tables have 3 sections. • Tier: 12" deep x 10" high. 	30" x 24"	Please specify child 27" or adult 29"	GLSS-3024-__-A	\$1,138
	30" x 30"		GLSS-3030-__-A	1,251
	30" x 36"		GLSS-3036-__-A	1,377
	36" x 24"		GLSS-3624-__-A	1,194
	36" x 30"		GLSS-3630-__-A	1,314
	36" x 36"		GLSS-3636-__-A	1,445
	60" x 30"		GLSS-6030-__-A	2,123
	72" x 30"		GLSS-7230-__-A	2,406
	96" x 30"		GLSS-9630-__-A	2,688
	 <p>PAC Table Double-Sided, Single Tier</p> <ul style="list-style-type: none"> • 60 and 72" wide tables have 2 sections. • 96" wide tables have 3 sections. • Tier: 24" deep x 10" high. 		30" x 48"	Please specify child 27" or adult 29"
30" x 60"		GLDS-3060-__-A	1,922	
30" x 72"		GLDS-3072-__-A	2,014	
36" x 48"		GLDS-3648-__-A	1,921	
36" x 60"		GLDS-3660-__-A	2,018	
36" x 72"		GLDS-3672-__-A	2,114	
60" x 48"		GLDS-6048-__-A	2,829	
60" x 52"		GLDS-6052-__-A	2,971	
72" x 48"		GLDS-7248-__-A	3,113	
72" x 52"		GLDS-7252-__-A	3,254	
96" x 48"		GLDS-9648-__-A	3,678	
96" x 52"		GLDS-9652-__-A	3,821	
 <p>Study Table Double-Sided, Single Tier with Shelf</p>	60" x 48"	Please specify child 27" or adult 29"	GLST-6048-__-A	2,845
	72" x 48"		GLST-7248-__-A	3,129

Reading, PAC & Study Table Options for Universal LT & Universal Lines

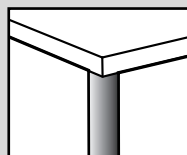

G94
 3" diameter black powder coat leg.
 Deduct \$100 per table.

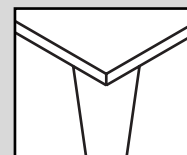

G95
 Wood tapered leg.
 Add \$250 per table.

Options

- 033 – Grommet +\$55.
- 200 – Plastic laminate top, no additional charge
- G87 – Lumbercore top +10%

(Additional options, see back of book pages 70 – 71)

Carrels

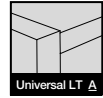

SINGLE UNITS

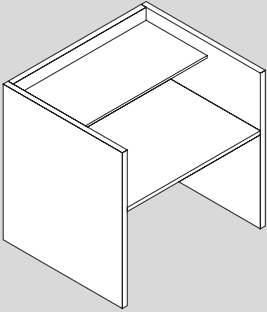
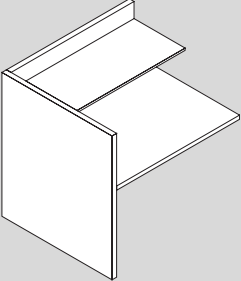
		Width	Depth	Ht.	Style Number	List Price
	Single-Faced Starter Carrel with Full End Panel	36"	31"	48"	GLFCS-36-A	\$1,686
		48"	31"	48"	GLFCS-48-A	1,739
	Single-Faced Add-On Carrel with Full End Panel	36"	31"	48"	GLFCA-36-A	1,587
		48"	31"	48"	GLFCA-48-A	1,644

DOUBLE UNITS

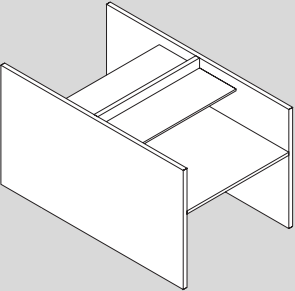
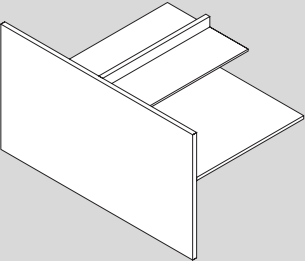
	Double-Faced Starter Carrel with Full End Panel	36"	62"	48"	GLFDS-36-A	3,442
		48"	62"	48"	GLFDS-48-A	3,479
	Double-Faced Add-On Carrel with Full End Panel	36"	62"	48"	GLFDA-36-A	3,175
		48"	62"	48"	GLFDA-48-A	3,351

Carrels

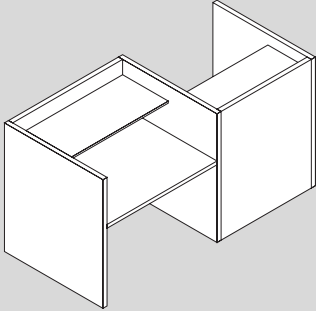
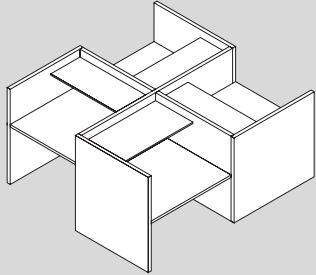

REVERSE & RADIATING UNITS

	Width	Depth	Ht.	Style Number	List Price
	71"	31"	48"	GLFCR-71-A	\$3,271
	95"	31"	48"	GLFCR-95-A	3,385
	65"	65"	48"	GLFCQ-65-A	6,750
	77"	77"	48"	GLFCQ-77-A	6,880

Options

- 031 – Full articulating keyboard arm +\$458.
- 033 – Grommet +\$55.
- 036 – Black plastic cable raceway +\$8. per linear foot
- 036A – Black plastic cable raceway for a vertical surface +\$8. per linear foot
- 039 – Multi-outlet strip +\$65.
- 200 – Plastic laminate worksurface, no additional charge
- 070 – Task light +\$308.
- G90 – VDT package w/integrated suspension system +\$1320.

(Additional options, see back of book pages 70 – 71)

Accessories

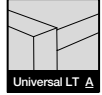

LECTERNS & STANDS

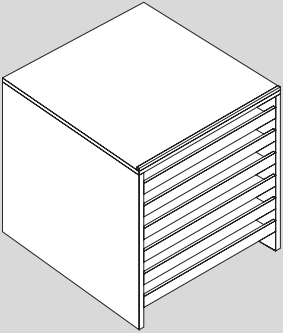
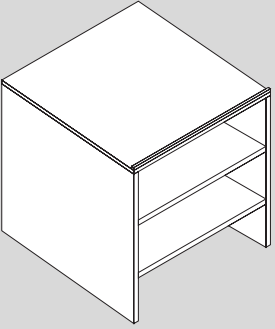
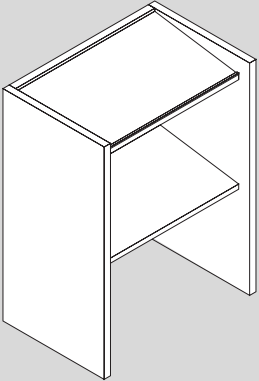
		Width	Depth	Ht.	Style Number	List Price
	Atlas Stand <ul style="list-style-type: none"> Sloped top 6 pull-out shelves 	30"	29"	34"	GLAS-3034-A	\$2,551
		30"	29"	45"	GLAS-3045-A	2,688
	Dictionary Stand <ul style="list-style-type: none"> Sloped top 2 adjustable shelves 	30"	29"	34"	GLDS-3034-A	1,280
		30"	29"	45"	GLDS-3045-A	1,416
	Lectern <ul style="list-style-type: none"> Sloped top shelf 1 adjustable shelf 	24"	16"	45"	GLL-2445-A	1,282
		30"	16"	45"	GLL-3045-A	1,800
		36"	16"	45"	GLL-3645-A	2,250

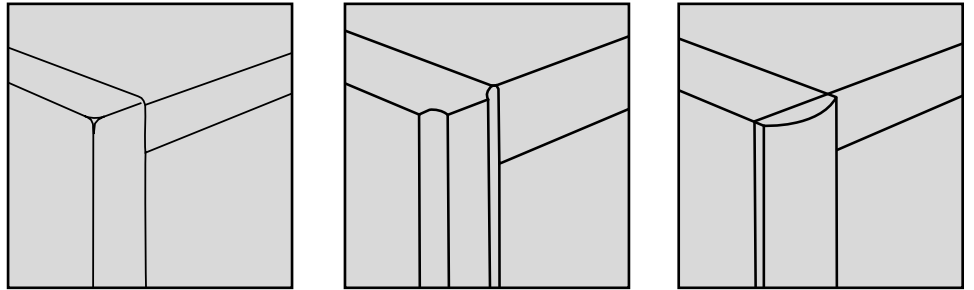

Universal

arnoldkolax
Arnold Kolax Furniture, Inc.

End Panels

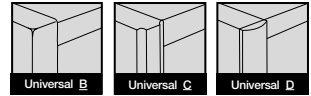

SINGLE-SIDED END PANELS

	Width	Ht.	Style Number	List Price	Options (see back of book)
 <p>Single-Sided End Panel</p> <ul style="list-style-type: none"> • 1" thick 	8" W	30"	GLSAX-308-__	\$119	G89 – 108" high +15% to 90" high price
		36"	GLSAX-368-__	128	
		42"	GLSAX-428-__	138	
		48"	GLSAX-488-__	150	
		60"	GLSAX-608-__	160	
		66"	GLSAX-668-__	171	
		72"	GLSAX-728-__	181	
		84"	GLSAX-848-__	197	
		90"	GLSAX-908-__	216	
	10" W	30"	GLSAX-3010-__	132	
		36"	GLSAX-3610-__	142	
		42"	GLSAX-4210-__	154	
		48"	GLSAX-4810-__	167	
		60"	GLSAX-6010-__	178	
		66"	GLSAX-6610-__	190	
		72"	GLSAX-7210-__	201	
		84"	GLSAX-8410-__	218	
		90"	GLSAX-9010-__	240	
	12" W	30"	GLSAX-3012-__	145	
		36"	GLSAX-3612-__	156	
		42"	GLSAX-4212-__	169	
		48"	GLSAX-4812-__	183	
		60"	GLSAX-6012-__	196	
		66"	GLSAX-6612-__	209	
		72"	GLSAX-7212-__	221	
		84"	GLSAX-8412-__	240	
		90"	GLSAX-9012-__	264	
	15" W	30"	GLSAX-3015-__	159	
		36"	GLSAX-3615-__	170	
		42"	GLSAX-4215-__	184	
		48"	GLSAX-4815-__	200	
		60"	GLSAX-6015-__	213	
		66"	GLSAX-6615-__	228	
72"		GLSAX-7215-__	241		
84"		GLSAX-8415-__	262		
90"		GLSAX-9015-__	289		
16" W	30"	GLSAX-3016-__	163		
	36"	GLSAX-3616-__	175		
	42"	GLSAX-4216-__	189		
	48"	GLSAX-4816-__	205		
	60"	GLSAX-6016-__	219		
	66"	GLSAX-6616-__	233		
	72"	GLSAX-7216-__	247		
	84"	GLSAX-8416-__	269		
	90"	GLSAX-9016-__	296		

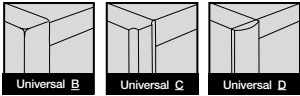

End Panels

DOUBLE-SIDED END PANELS

	Width	Ht.	Style Number	List Price	Options (see back of book)
 <p>Double-Sided End Panel</p> <ul style="list-style-type: none"> • 1" thick 	20" W	30"	GLSDX-3020-__	\$279	G89 – 108" high +15% to 90" high price
		36"	GLSDX-3620-__	289	
		42"	GLSDX-4220-__	306	
		48"	GLSDX-4820-__	331	
		60"	GLSDX-6020-__	355	
		66"	GLSDX-6620-__	378	
		72"	GLSDX-7220-__	401	
		84"	GLSDX-8420-__	445	
		90"	GLSDX-9020-__	481	
	24" W	30"	GLSDX-3024-__	307	
		36"	GLSDX-3624-__	318	
		42"	GLSDX-4224-__	337	
		48"	GLSDX-4824-__	364	
		60"	GLSDX-6024-__	390	
		66"	GLSDX-6624-__	416	
		72"	GLSDX-7224-__	441	
		84"	GLSDX-8424-__	490	
		90"	GLSDX-9024-__	529	
	30" W	30"	GLSDX-3030-__	348	
		36"	GLSDX-3630-__	361	
		42"	GLSDX-4230-__	383	
		48"	GLSDX-4830-__	413	
		60"	GLSDX-6030-__	444	
		66"	GLSDX-6630-__	473	
		72"	GLSDX-7230-__	501	
		84"	GLSDX-8430-__	556	
		90"	GLSDX-9030-__	602	

Reading Tables

Please specify child 27" or adult 29".

Example: Child: GLRT-4230-27-__
Adult: GLRT-7242-29-__

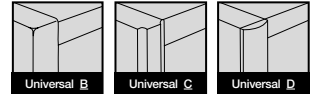

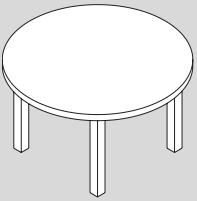
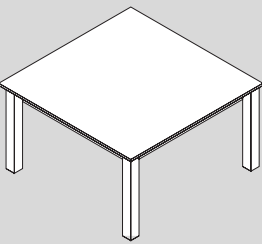
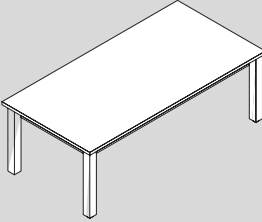
		Top Size (w x d)	Height	Style Number	List Price
	Round Reading Table	36" dia.		GLRT-36-__-__	\$1,393
		42" dia.		GLRT-42-__-__	1,471
		48" dia.	Please specify child 27" or adult 29"	GLRT-48-__-__	1,547
		54" dia.		GLRT-54-__-__	2,522
		60" dia.		GLRT-60-__-__	3,027
		72" dia.		GLRT-72-__-__	3,994
	Square Reading Table • 3" high apron	36" x 36"		GLRT-3636-__-__	1,134
		42" x 42"		GLRT-4242-__-__	1,208
		48" x 48"	Please specify child 27" or adult 29"	GLRT-4848-__-__	1,505
		54" x 54"		GLRT-5454-__-__	2,077
		60" x 60"		GLRT-6060-__-__	2,732
	Rectangular Reading Table • 3" high apron	42" x 24"		GLRT-4224-__-__	1,015
		48" x 24"		GLRT-4824-__-__	1,163
		54" x 24"	Please specify child 27" or adult 29"	GLRT-5424-__-__	1,184
		60" x 24"		GLRT-6024-__-__	1,211
		72" x 24"		GLRT-7224-__-__	1,288
		84" x 24"		GLRT-8424-__-__	1,422
		42" x 30"		GLRT-4230-__-__	1,059
		48" x 30"		GLRT-4830-__-__	1,208
		54" x 30"		GLRT-5430-__-__	1,229
		60" x 30"		GLRT-6030-__-__	1,256
		72" x 30"		GLRT-7230-__-__	1,333
		84" x 30"		GLRT-8430-__-__	1,467
		96" x 30"		GLRT-9630-__-__	1,601
		42" x 36"		GLRT-4236-__-__	1,148
		48" x 36"		GLRT-4836-__-__	1,295
		54" x 36"		GLRT-5436-__-__	1,318
		60" x 36"		GLRT-6036-__-__	1,345
		72" x 36"		GLRT-7236-__-__	1,444
		84" x 36"		GLRT-8436-__-__	1,534
		96" x 36"		GLRT-9636-__-__	1,668
		48" x 42"		GLRT-4842-__-__	1,739
		54" x 42"		GLRT-5442-__-__	1,763
		60" x 42"		GLRT-6042-__-__	1,849
		72" x 42"		GLRT-7242-__-__	1,941
84" x 42"		GLRT-8442-__-__	2,084		
96" x 42"		GLRT-9642-__-__	2,292		

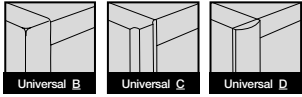

Please specify child 27" or adult 29".
 Example: Child: GLRT-4230-27-__
 Adult: GLRT-7242-29-__

Study Tables

		Top Size (w x d)	Height	Style Number	List Price
<p>PAC Table Single-Sided, Single Tier</p> <ul style="list-style-type: none"> • 60 and 72" wide tables have 2 sections. • 96" wide tables have 3 sections. • Tier: 12" deep x 10" high. 		30" x 24"		GLSS-3024-__-__	\$1,300
		30" x 30"		GLSS-3030-__-__	1,430
		30" x 36"	Please specify child 27" or adult 29"	GLSS-3036-__-__	1,573
		36" x 24"		GLSS-3624-__-__	1,365
		36" x 30"		GLSS-3630-__-__	1,502
		36" x 36"		GLSS-3636-__-__	1,652
		60" x 30"		GLSS-6030-__-__	2,335
		72" x 30"		GLSS-7230-__-__	2,647
		96" x 30"		GLSS-9630-__-__	2,957
	<p>PAC Table Double-Sided, Single Tier</p> <ul style="list-style-type: none"> • 60 and 72" wide tables have 2 sections. • 96" wide tables have 3 sections. • Tier: 24" deep x 10" high. 		30" x 48"		GLDS-3048-__-__
		30" x 60"		GLDS-3060-__-__	2,196
		30" x 72"		GLDS-3072-__-__	2,301
		36" x 48"	Please specify child 27" or adult 29"	GLDS-3648-__-__	2,196
		36" x 60"		GLDS-3660-__-__	2,306
		36" x 72"		GLDS-3672-__-__	2,416
		60" x 48"		GLDS-6048-__-__	3,112
		60" x 52"		GLDS-6052-__-__	3,268
		72" x 48"		GLDS-7248-__-__	3,424
		72" x 52"		GLDS-7252-__-__	3,579
	96" x 48"		GLDS-9648-__-__	4,046	
<p>Study Table Double-Sided, Single Tier with Shelf</p>		60" x 48"	Please specify child 27" or adult 29"	GLST-6048-__-__	3,251
		72" x 48"		GLST-7248-__-__	3,576

Reading, PAC & Study Table
Options for Universal LT &
Universal Lines

G94
3" diameter black powder coat leg.
Deduct \$100 per table.

G95
Wood tapered leg.
Add \$250 per table.

Options
 033 – Grommet +\$55.
 200 – Plastic laminate top, no additional charge
 G87 – Lumbercore top +10%
 (Additional options, see back of book pages 70 – 71)

Carrels

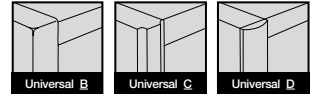

SINGLE UNITS

		Width	Depth	Ht.	Style Number	List Price
	Single-Faced Starter Carrel with Full End Panel	36"	31"	48"	GLFCS-36	\$1,927
		48"	31"	48"	GLFCS-48	1,987
	Single-Faced Add-On Carrel with Full End Panel	36"	31"	48"	GLFCA-36	1,813
		48"	31"	48"	GLFCA-48	1,879

DOUBLE UNITS

	Double-Faced Starter Carrel with Full End Panel	36"	62"	48"	GLFDS-36	3,934
		48"	62"	48"	GLFDS-48	3,976
	Double-Faced Add-On Carrel with Full End Panel	36"	62"	48"	GLFDA-36	3,628
		48"	62"	48"	GLFDA-48	3,830

Carrels

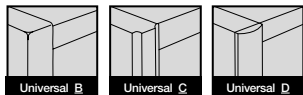

REVERSE & RADIATING UNITS

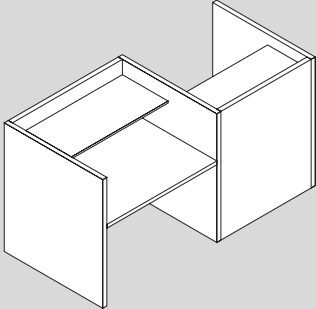
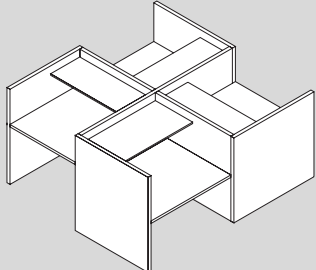
	Width	Depth	Ht.	Style Number	List Price
	71"	31"	48"	GLFCR-71-__	\$3,738
	95"	31"	48"	GLFCR-95-__	3,868
	65"	65"	48"	GLFCQ-65	7,714
	77"	77"	48"	GLFCQ-77	7,863

Options

- 031 – Full articulating keyboard arm +\$458.
- 033 – Grommet +\$55.
- 036 – Black plastic cable raceway +\$8. per linear foot
- 036A – Black plastic cable raceway for a vertical surface +\$8. per linear foot
- 039 – Multi-outlet strip +\$65.
- 200 – Plastic laminate worksurface, no additional charge
- 070 – Task light +\$308.
- G90 – VDT package w/integrated suspension system +\$1320.

(Additional options, see back of book pages 70 – 71)

Accessories

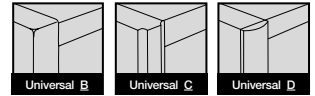

LECTERNS & STANDS

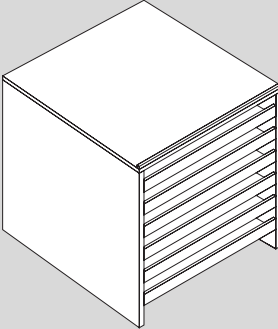
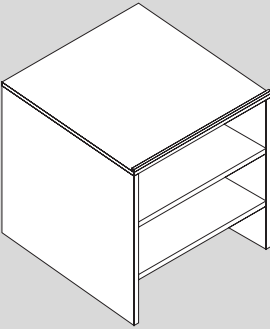
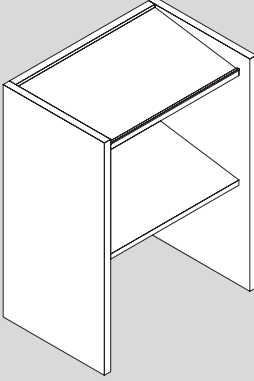
		Width	Depth	Ht.	Style Number	List Price
	Atlas Stand <ul style="list-style-type: none"> • Sloped top • 6 pull-out shelves 	30"	29"	34"	GLAS-3034	\$2,916
		30"	29"	45"	GLAS-3045	3,072
	Dictionary Stand <ul style="list-style-type: none"> • Sloped top • 2 adjustable shelves 	30"	29"	34"	GLDS-3034	1,463
		30"	29"	45"	GLDS-3045	1,619
	Lectern <ul style="list-style-type: none"> • Sloped top shelf • 1 adjustable shelf 	24"	16"	45"	GLL-2445	1,465
		30"	16"	45"	GLL-3045	2,000
		36"	16"	45"	GLL-3645	2,500

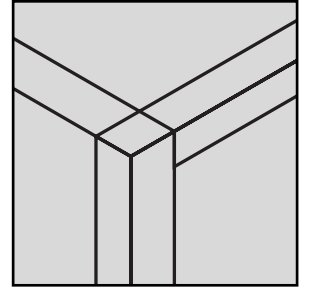

Pacific

arnoldkolax

Arnold Kolax Furniture, Inc.

End Panels

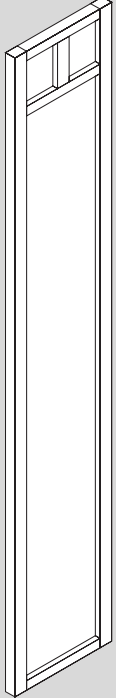

SINGLE-SIDED END PANELS

	Width	Ht.	Style Number	List Price	Options (see back of book)
 <p>Single-Sided End Panel</p> <ul style="list-style-type: none"> • 1 1/4" thick 	8" W	30"	GLPAX-308	\$210	G89 – 108" high +15% to 90" high price
		36"	GLPAX-368	225	
		42"	GLPAX-428	243	
		48"	GLPAX-488	264	
		60"	GLPAX-608	282	
		66"	GLPAX-668	300	
		72"	GLPAX-728	318	
		84"	GLPAX-848	346	
		90"	GLPAX-908	381	
	10" W	30"	GLPAX-3010	233	
		36"	GLPAX-3610	250	
		42"	GLPAX-4210	271	
		48"	GLPAX-4810	294	
		60"	GLPAX-6010	313	
		66"	GLPAX-6610	334	
		72"	GLPAX-7210	354	
		84"	GLPAX-8410	385	
		90"	GLPAX-9010	423	
	12" W	30"	GLPAX-3012	256	
		36"	GLPAX-3612	275	
		42"	GLPAX-4212	298	
		48"	GLPAX-4812	323	
		60"	GLPAX-6012	345	
		66"	GLPAX-6612	367	
		72"	GLPAX-7212	389	
		84"	GLPAX-8412	423	
		90"	GLPAX-9012	466	
	15" W	30"	GLPAX-3015	280	
		36"	GLPAX-3615	300	
		42"	GLPAX-4215	325	
		48"	GLPAX-4815	352	
		60"	GLPAX-6015	376	
		66"	GLPAX-6615	401	
		72"	GLPAX-7215	425	
		84"	GLPAX-8415	462	
		90"	GLPAX-9015	508	
16" W	30"	GLPAX-3016	287		
	36"	GLPAX-3616	308		
	42"	GLPAX-4216	333		
	48"	GLPAX-4816	361		
	60"	GLPAX-6016	385		
	66"	GLPAX-6616	411		
	72"	GLPAX-7216	435		
	84"	GLPAX-8416	473		
	90"	GLPAX-9016	521		

Reading Tables

Please specify child 27" or adult 29".
 Example: Child: GLPRT-4230-27
 Adult: GLPRT-7242-29

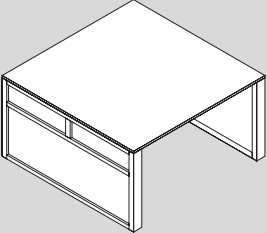
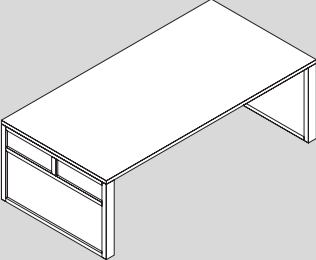

		Top Size (w x d)	Height	Style Number	List Price
	Square Reading Table	36" x 36"		GLPRT-3636-__	\$1,735
		42" x 42"		GLPRT-4242-__	1,849
		48" x 48"		GLPRT-4848-__	2,303
		54" x 54"	Please specify child 27" or adult 29"	GLPRT-5454-__	3,179
		60" x 60"		GLPRT-6060-__	4,180
	Rectangular Reading Table	42 x 24"		GLPRT-4224-__	1,553
		48 x 24"		GLPRT-4824-__	1,780
		54 x 24"	Please specify child 27" or adult 29"	GLPRT-5424-__	1,812
		60 x 24"		GLPRT-6024-__	1,854
		72 x 24"		GLPRT-7224-__	1,971
		84 x 24"		GLPRT-8424-__	2,177
		42 x 30"		GLPRT-4230-__	1,621
		48 x 30"		GLPRT-4830-__	1,848
		54 x 30"		GLPRT-5430-__	1,880
		60 x 30"		GLPRT-6030-__	1,922
		72 x 30"		GLPRT-7230-__	2,039
		84 x 30"		GLPRT-8430-__	2,245
		96 x 30"		GLPRT-9630-__	2,450
		42 x 36"		GLPRT-4236-__	1,757
		48 x 36"		GLPRT-4836-__	1,982
		54 x 36"		GLPRT-5436-__	2,016
		60 x 36"		GLPRT-6036-__	2,058
		72 x 36"		GLPRT-7236-__	2,209
		84 x 36"		GLPRT-8436-__	2,347
		96 x 36"		GLPRT-9636-__	2,552
		48 x 42"		GLPRT-4842-__	2,644
		54 x 42"		GLPRT-5442-__	2,680
		60 x 42"		GLPRT-6042-__	2,811
		72 x 42"		GLPRT-7242-__	2,950
		84 x 42"		GLPRT-8442-__	3,168
		96 x 42"		GLPRT-9642-__	3,484

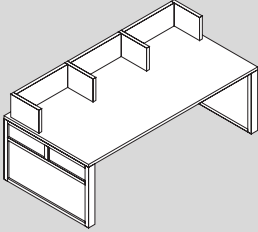
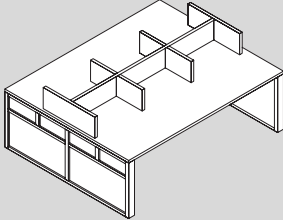
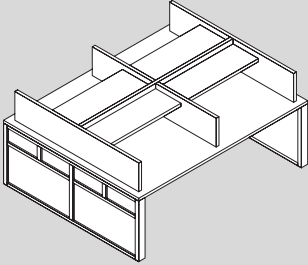

Study Tables

		Top Size (w x d)	Height	Style Number	List Price
 <p>PAC Table Single-Sided, Single Tier</p> <ul style="list-style-type: none"> • 60 and 72" wide tables have 2 sections. • 96" wide tables have 3 sections. • Tier: 12" deep x 10" high. 		30" x 24"		GLPSS-3024-__	\$1,675
		30" x 30"		GLPSS-3030-__	1,842
		30" x 36"	Please specify child 27" or adult 29"	GLPSS-3036-__	2,026
		36" x 24"		GLPSS-3624-__	1,758
		36" x 30"		GLPSS-3630-__	1,934
		36" x 36"		GLPSS-3636-__	2,128
		60" x 30"		GLPSS-6030-__	2,919
		72" x 30"		GLPSS-7230-__	3,309
		96" x 30"		GLPSS-9630-__	3,697
 <p>PAC Table Double-Sided, Single Tier</p> <ul style="list-style-type: none"> • 60 and 72" wide tables have 2 sections. • 96" wide tables have 3 sections. • Tier: 24" deep x 10" high. 		30" x 48"		GLPDS-3048-__	2,424
		30" x 60"		GLPDS-3060-__	2,546
		30" x 72"	Please specify child 27" or adult 29"	GLPDS-3072-__	2,667
		36" x 48"		GLPDS-3648-__	2,545
		36" x 60"		GLPDS-3660-__	2,673
		36" x 72"		GLPDS-3672-__	2,801
		60" x 48"		GLPDS-6048-__	3,891
		60" x 52"		GLPDS-6052-__	4,085
		72" x 48"		GLPDS-7248-__	4,280
		72" x 52"		GLPDS-7252-__	4,474
		96" x 48"		GLPDS-9648-__	5,058
		96" x 52"		GLPDS-9652-__	5,253
 <p>Study Table Double-Sided, Single Tier with Shelf</p>		60" x 48"	Please specify child 27" or adult 29"	GLPST-6048-__	4,187
		72" x 48"		GLPST-7248-__	4,606

Options

033 – Grommet +\$55.

200 – Plastic laminate top, no additional charge

G87 – Lumbercore top +10%

(Additional options, see back of book pages 70 – 71)

Carrels

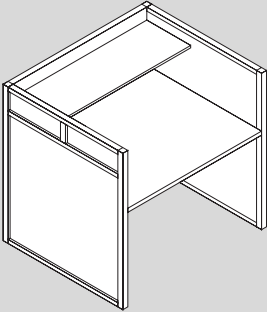
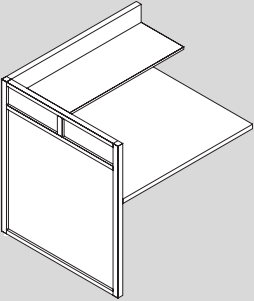

SINGLE UNITS

		Width	Depth	Ht.	Style Number	List Price
	Single-Faced Starter Carrel with Full End Panel	36"	31"	48"	GLPFCS-36	\$2,608
		48"	31"	48"	GLPFCS-48	2,678
	Single-Faced Adder Carrel with Full End Panel	36"	31"	48"	GLPFCA-36	2,233
		48"	31"	48"	GLPFCA-48	2,304

DOUBLE UNITS

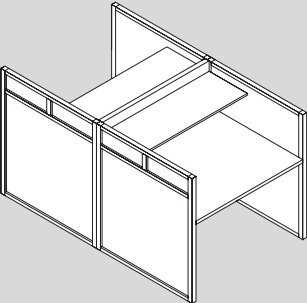
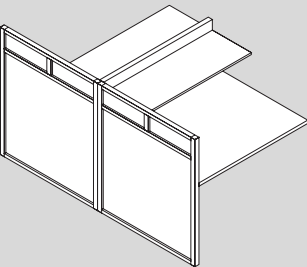
	Double-Faced Starter Carrel with Full End Panel	36"	62"	48"	GLPFDS-36	5,263
		48"	62"	48"	GLPFDS-48	5,286
	Double-Faced Adder Carrel with Full End Panel	36"	62"	48"	GLPFDA-36	5,215
		48"	62"	48"	GLPFDA-48	5,236

Carrels

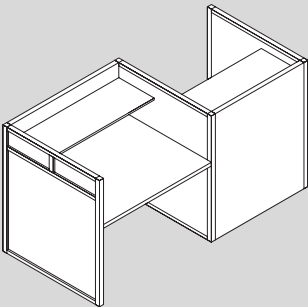
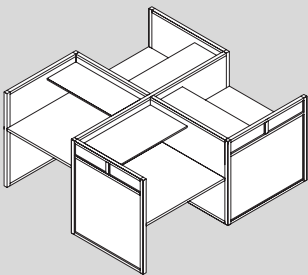

REVERSE & RADIATING UNITS

		Width	Depth	Ht.	Style Number	List Price
	Reverse Double Study Carrel	71"	31"	48"	GLPFCR-71	\$4,838
		95"	31"	48"	GLPFCR-95	4,984
	Radiating Quad Study Carrel	65"	65"	48"	GLPFCQ-65	10,549
		77"	77"	48"	GLPFCQ-77	10,692

Options

- 031 – Full articulating keyboard arm +\$458.
 - 033 – Grommet +\$55.
 - 036 – Black plastic cable raceway +\$8. per linear foot
 - 036A – Black plastic cable raceway for a vertical surface +\$8. per linear foot
 - 039 – Multi-outlet strip +\$65.
 - 200 – Plastic laminate worksurface, no additional charge
 - 070 – Task light +\$308.
 - G90 – VDT package w/integrated suspension system +\$1320.
- (Additional options, see back of book pages 70 – 71)

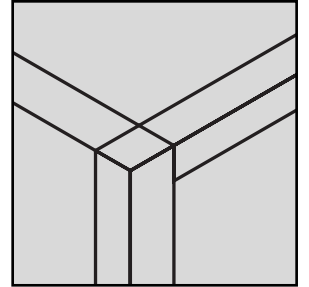

Mountain

arnoldkolax

Arnold Kolax Furniture, Inc.

End Panels



SINGLE-SIDED END PANELS

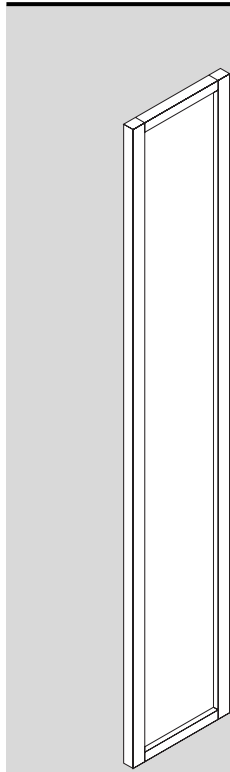

Single-Sided End Panel

- 1 1/4" thick

Width	Ht.	Style Number	List Price	Options (see back of book)
8" W	30"	GLMAX-308	\$210	G89 – 108" high +15% to 90" high price
	36"	GLMAX-368	225	
	42"	GLMAX-428	243	
	48"	GLMAX-488	264	
	60"	GLMAX-608	282	
	66"	GLMAX-668	300	
	72"	GLMAX-728	318	
	84"	GLMAX-848	346	
	90"	GLMAX-908	381	
	10" W	30"	GLMAX-3010	
36"		GLMAX-3610	250	
42"		GLMAX-4210	271	
48"		GLMAX-4810	294	
60"		GLMAX-6010	313	
66"		GLMAX-6610	334	
72"		GLMAX-7210	354	
84"		GLMAX-8410	385	
90"		GLMAX-9010	423	
12" W		30"	GLMAX-3012	256
	36"	GLMAX-3612	275	
	42"	GLMAX-4212	298	
	48"	GLMAX-4812	323	
	60"	GLMAX-6012	345	
	66"	GLMAX-6612	367	
	72"	GLMAX-7212	389	
	84"	GLMAX-8412	423	
	90"	GLMAX-9012	466	
	15" W	30"	GLMAX-3015	280
36"		GLMAX-3615	300	
42"		GLMAX-4215	325	
48"		GLMAX-4815	352	
60"		GLMAX-6015	376	
66"		GLMAX-6615	401	
72"		GLMAX-7215	425	
84"		GLMAX-8415	462	
90"		GLMAX-9015	508	
16" W		30"	GLMAX-3016	287
	36"	GLMAX-3616	308	
	42"	GLMAX-4216	333	
	48"	GLMAX-4816	361	
	60"	GLMAX-6016	385	
	66"	GLMAX-6616	411	
	72"	GLMAX-7216	435	
	84"	GLMAX-8416	473	
	90"	GLMAX-9016	521	

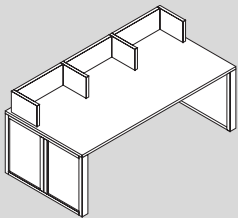
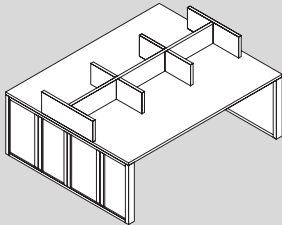
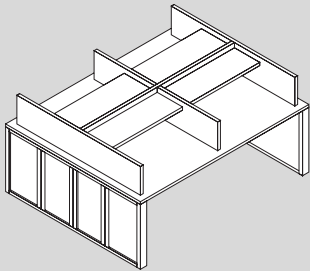

Study Tables

		Top Size (w x d)	Height	Style Number	List Price
 <p>PAC Table Single-Sided, Single Tier</p> <ul style="list-style-type: none"> • 60 and 72" wide tables have 2 sections. • 96" wide tables have 3 sections. • Tier: 12" deep x 10" high. 		30" x 24"		GLMSS-3024-__	\$1,673
		30" x 30"		GLMSS-3030-__	1,842
		30" x 36"	Please specify child 27" or adult 29"	GLMSS-3036-__	2,026
		36" x 24"		GLMSS-3624-__	1,758
		36" x 30"		GLMSS-3630-__	1,934
		36" x 36"		GLMSS-3636-__	2,128
		60" x 30"		GLMSS-6030-__	2,919
		72" x 30"		GLMSS-7230-__	3,309
		96" x 30"		GLMSS-9630-__	3,697
 <p>PAC Table Double-Sided, Single Tier</p> <ul style="list-style-type: none"> • 60 and 72" wide tables have 2 sections. • 96" wide tables have 3 sections. • Tier: 24" deep x 10" high. 		30" x 48"		GLMDS-3048-__	2,693
		30" x 60"		GLMDS-3060-__	2,829
		30" x 72"		GLMDS-3072-__	2,964
		36" x 48"	Please specify child 27" or adult 29"	GLMDS-3648-__	2,828
		36" x 60"		GLMDS-3660-__	2,970
		36" x 72"		GLMDS-3672-__	3,112
		60" x 48"		GLMDS-6048-__	3,891
		60" x 52"		GLMDS-6052-__	4,085
		72" x 48"		GLMDS-7248-__	4,280
		72" x 52"		GLMDS-7252-__	4,474
		96" x 48"		GLMDS-9648-__	5,058
	96" x 52"		GLMDS-9652-__	5,253	
 <p>Study Table Double-Sided, Single Tier with Shelf</p>		60" x 48"	Please specify child 27" or adult 29"	GLMST-6048-__	4,187
		72" x 48"		GLMST-7248-__	4,606

Options

033 – Grommet +\$55.

200 – Plastic laminate top, no additional charge

G87 – Lumbercore top +10%

(Additional options, see back of book pages 70 – 71)

Carrels

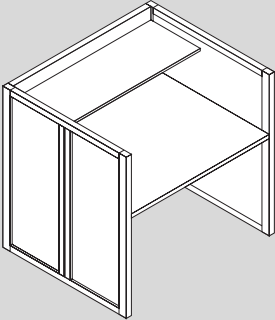
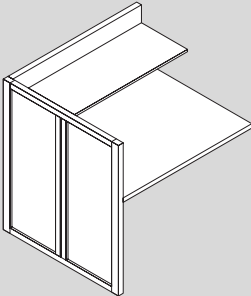

SINGLE UNITS

		Width	Depth	Ht.	Style Number	List Price
	Single-Faced Starter Carrel with Full End Panel	36"	31"	48"	GLMFCS-36	\$2,608
		48"	31"	48"	GLMFCS-48	2,678
	Single-Faced Adder Carrel with Full End Panel	36"	31"	48"	GLMFCA-36	2,233
		48"	31"	48"	GLMFCA-48	2,304

DOUBLE UNITS

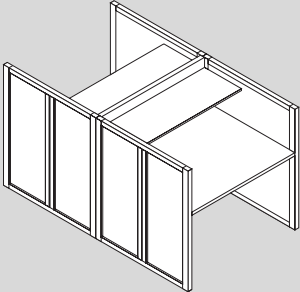
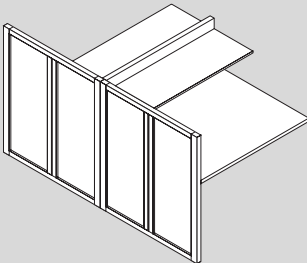
	Double-Faced Starter Carrel with Full End Panel	36"	62"	48"	GLMFDS-36	5,263
		48"	62"	48"	GLMFDS-48	5,286
	Double-Faced Adder Carrel with Full End Panel	36"	62"	48"	GLMFDA-36	5,215
		48"	62"	48"	GLMFDA-48	5,236



Carrels

REVERSE & RADIATING UNITS

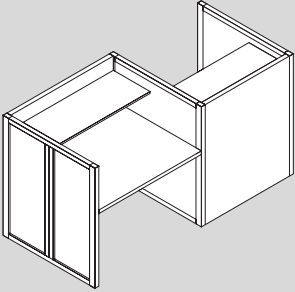
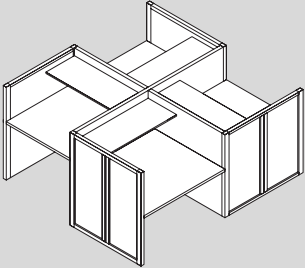
		Width	Depth	Ht.	Style Number	List Price
	Reverse Double Study Carrel	71"	31"	48"	GLMFCR-71	\$4,838
		95"	31"	48"	GLMFCR-95	4,984
	Radiating Quad Study Carrel	65"	65"	48"	GLMFCQ-65	10,549
		77"	77"	48"	GLMFCQ-77	10,692

Options

- 031 – Full articulating keyboard arm +\$458.
 - 033 – Grommet +\$55.
 - 036 – Black plastic cable raceway +\$8. per linear foot
 - 036A – Black plastic cable raceway for a vertical surface +\$8. per linear foot
 - 039 – Multi-outlet strip +\$65.
 - 200 – Plastic laminate worksurface, no additional charge
 - 070 – Task light +\$308.
 - G90 – VDT package w/integrated suspension system +\$1320.
- (Additional options, see back of book pages 70 – 71)

Accessories

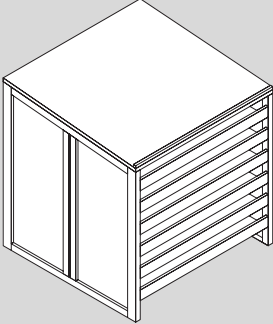
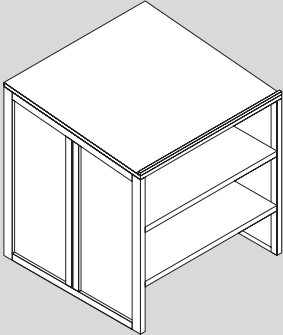
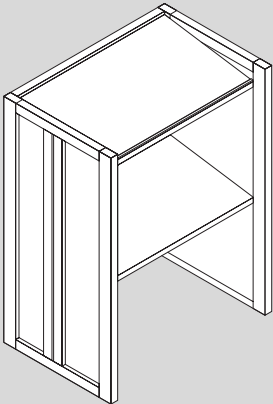

LECTERNS & STANDS

		Width	Depth	Ht.	Style Number	List Price
 <p>Atlas Stand</p> <ul style="list-style-type: none"> • Sloped top • 6 pull-out shelves 	30"	29"	34"	GLMAS-3034	\$3,527	
	30"	29"	45"	GLMAS-3045	3,682	
 <p>Dictionary Stand</p> <ul style="list-style-type: none"> • Sloped top • 2 adjustable shelves 	30"	29"	34"	GLMDS-3034	2,126	
	30"	29"	45"	GLMDS-3045	2,251	
 <p>Lectern</p> <ul style="list-style-type: none"> • Sloped top shelf • 1 adjustable shelf 	24"	16"	45"	GLML-2445	2,103	
	30"	16"	45"	GLML-3045	2,300	
	36"	16"	45"	GLML-3645	2,900	

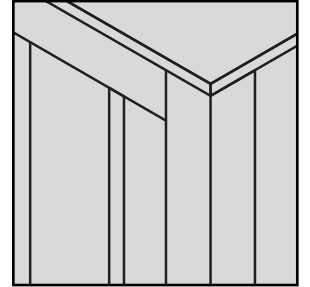

Desert

arnoldkolax

Arnold Kolax Furniture, Inc.

Reading Tables

Please specify child 27" or adult 29".

Example: Child: GLRT-4230-27
Adult: GLRT-7242-29

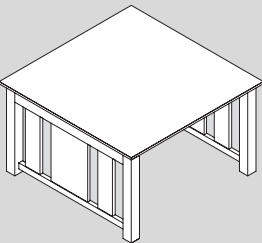
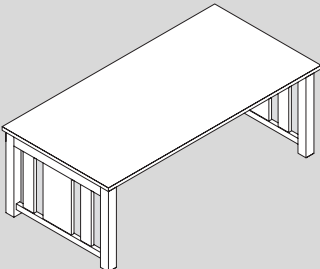

		Top Size (w x d)	Height	Style Number	List Price
	Round Reading Table	36" dia.		GLDRT-36-__	\$1,919
		42" dia.		GLDRT-42-__	2,026
		48" dia.	Please specify child 27" or adult 29"	GLDRT-48-__	2,131
		54" dia.		GLDRT-54-__	3,473
		60" dia.		GLDRT-60-__	4,113
				72" dia.	GLDRT-72-__
	Square Reading Table	36" x 36"		GLDRT-3636-__	1,275
		42" x 42"		GLDRT-4242-__	1,414
		48" x 48"	Please specify child 27" or adult 29"	GLDRT-4848-__	1,829
		54" x 54"		GLDRT-5454-__	2,524
		60" x 60"		GLDRT-6060-__	3,319
	Rectangular Reading Table	42" x 24"		GLDRT-4224-__	1,233
		48" x 24"		GLDRT-4824-__	1,414
		54" x 24"	Please specify child 27" or adult 29"	GLDRT-5424-__	1,439
		60" x 24"		GLDRT-6024-__	1,472
		72" x 24"		GLDRT-7224-__	1,565
		84" x 24"		GLDRT-8424-__	1,728
		42" x 30"		GLDRT-4230-__	1,287
		48" x 30"	GLDRT-4830-__	1,468	
		54" x 30"	GLDRT-5430-__	1,493	
		60" x 30"	GLDRT-6030-__	1,526	
		72" x 30"	GLDRT-7230-__	1,619	
		84" x 30"	GLDRT-8430-__	1,782	
		96" x 30"	GLDRT-9630-__	1,945	
		42" x 36"	GLDRT-4236-__	1,395	
		48" x 36"	GLDRT-4836-__	1,574	
		54" x 36"	GLDRT-5436-__	1,601	
		60" x 36"	GLDRT-6036-__	1,634	
		72" x 36"	GLDRT-7236-__	1,754	
		84" x 36"	GLDRT-8436-__	1,863	
		96" x 36"	GLDRT-9636-__	2,026	
48" x 42"	GLDRT-4842-__	2,113			
54" x 42"	GLDRT-5442-__	2,142			
60" x 42"	GLDRT-6042-__	2,247			
72" x 42"	GLDRT-7242-__	2,358			
84" x 42"	GLDRT-8442-__	2,532			
96" x 42"	GLDRT-9642-__	2,785			



Please specify child 27" or adult 29".
 Example: Child: GLRT-4230-27
 Adult: GLRT-7242-29

Study Tables

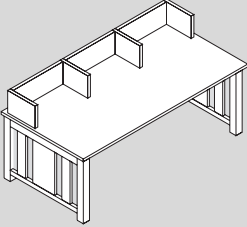
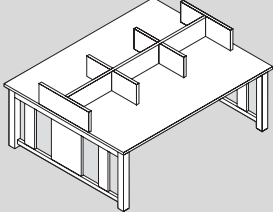
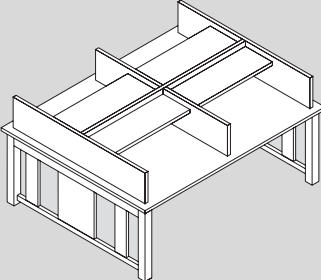
		Top Size (w x d)	Height	Style Number	List Price
 <p>PAC Table Single-Sided, Single Tier</p> <ul style="list-style-type: none"> • 60 and 72" wide tables have 2 sections. • 96" wide tables have 3 sections. • Tier: 12" deep x 10" high. 		30" x 24"		GLDSS-3024-__	\$1,881
		30" x 30"		GLDSS-3030-__	2,070
		30" x 36"	Please specify child 27" or adult 29"	GLDSS-3036-__	2,277
		36" x 24"		GLDSS-3624-__	1,975
		36" x 30"		GLDSS-3630-__	2,173
		36" x 36"		GLDSS-3636-__	2,390
		60" x 30"		GLDSS-6030-__	3,211
		72" x 30"		GLDSS-7230-__	3,640
		96" x 30"		GLDSS-9630-__	4,066
	 <p>PAC Table Double-Sided, Single Tier</p> <ul style="list-style-type: none"> • 60 and 72" wide tables have 2 sections. • 96" wide tables have 3 sections. • Tier: 24" deep x 10" high. 		30" x 48"		GLDDS-3048-__
		30" x 60"		GLDDS-3060-__	3,178
		30" x 72"	Please specify child 27" or adult 29"	GLDDS-3072-__	3,330
		36" x 48"		GLDDS-3648-__	3,177
		36" x 60"		GLDDS-3660-__	3,337
		36" x 72"		GLDDS-3672-__	3,496
		60" x 48"		GLDDS-6048-__	4,280
		60" x 52"		GLDDS-6052-__	4,493
		72" x 48"		GLDDS-7248-__	4,708
		72" x 52"		GLDDS-7252-__	4,922
	96" x 48"		GLDDS-9648-__	5,564	
	96" x 52"		GLDDS-9652-__	5,779	
 <p>Study Table Double-Sided, Single Tier with Shelf</p>		30" x 48"	Please specify child 27" or adult 29"	GLDST-3048-__	4,704
		30" x 60"		GLDST-3060-__	5,175

Options

- 033 – Grommet +\$55.
 - 200 – Plastic laminate top, no additional charge
 - G87 – Lumbercore top +10%
- (Additional options, see back of book pages 70 – 71)

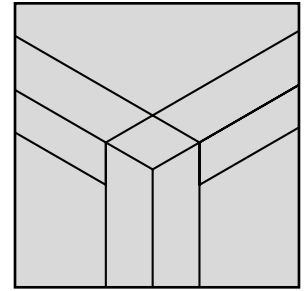

Baron

arnoldkolax

Arnold Kolax Furniture, Inc.

Reading Tables

Please specify child 27" or adult 29".
 Example: Child: GLRT-4230-27
 Adult: GLRT-7242-29

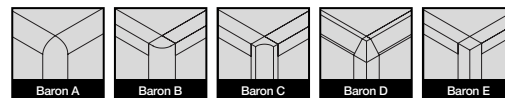

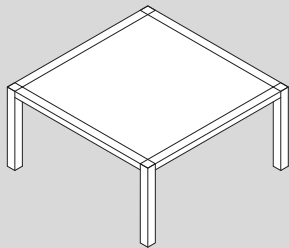
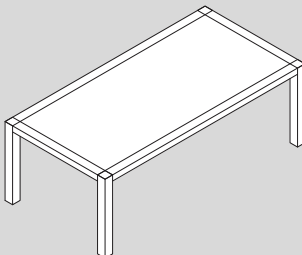
		Top Size (w x d)	Height	Style Number	List Price
	Square Reading Table	36" x 36"	Please specify child 27" or adult 29"	GLBRT-3636-__	\$1,275
		42" x 42"		GLBRT-4242-__	1,414
		48" x 48"		GLBRT-4848-__	1,829
		54" x 54"		GLBRT-5454-__	2,524
		60" x 60"		GLBRT-6060-__	3,319
	Rectangular Reading Table	42" x 24"	Please specify child 27" or adult 29"	GLBRT-4224-__	1,233
		48" x 24"		GLBRT-4824-__	1,414
		54" x 24"		GLBRT-5424-__	1,439
		60" x 24"		GLBRT-6024-__	1,472
		72" x 24"		GLBRT-7224-__	1,565
		84" x 24"		GLBRT-8424-__	1,728
		42" x 30"	Please specify child 27" or adult 29"	GLBRT-4230-__	1,287
		48" x 30"		GLBRT-4830-__	1,468
		54" x 30"		GLBRT-5430-__	1,493
		60" x 30"		GLBRT-6030-__	1,526
		72" x 30"		GLBRT-7230-__	1,619
		84" x 30"		GLBRT-8430-__	1,782
		96" x 30"	GLBRT-9630-__	1,945	
		42" x 36"		GLBRT-4236-__	1,395
		48" x 36"		GLBRT-4836-__	1,574
		54" x 36"		GLBRT-5436-__	1,601
		60" x 36"		GLBRT-6036-__	1,634
		72" x 36"		GLBRT-7236-__	1,754
		84" x 36"		GLBRT-8436-__	1,863
		96" x 36"	GLBRT-9636-__	2,026	
		48" x 42"		GLBRT-4842-__	2,113
		54" x 42"		GLBRT-5442-__	2,142
		60" x 42"		GLBRT-6042-__	2,247
		72" x 42"		GLBRT-7242-__	2,358
84" x 42"	GLBRT-8442-__	2,532			
96" x 42"	GLBRT-9642-__	2,785			

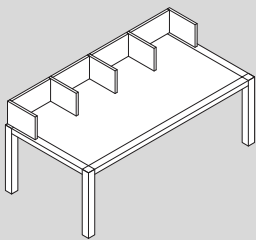
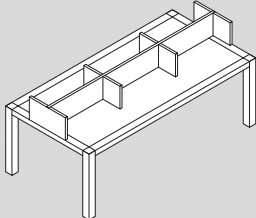
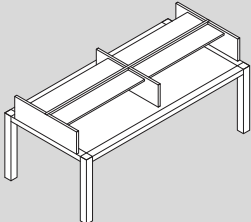

Study Tables

		Top Size (w x d)	Height	Style Number	List Price
 <p>PAC Table Single-Sided, Single Tier</p> <ul style="list-style-type: none"> • 60 and 72" wide tables have 2 sections. • 96" wide tables have 3 sections. • Tier: 12" deep x 10" high. 		30" x 24"		GLBSS-3024-__	\$1,881
		30" x 30"		GLBSS-3030-__	2,070
		30" x 36"		GLBSS-3036-__	2,277
		36" x 24"	Please specify child 27" or adult 29"	GLBSS-3624-__	1,975
		36" x 30"		GLBSS-3630-__	2,173
		36" x 36"		GLBSS-3636-__	2,390
		60" x 30"		GLBSS-6030-__	3,211
		72" x 30"		GLBSS-7230-__	3,640
		96" x 30"		GLBSS-9630-__	4,066
 <p>PAC Table Double-Sided, Single Tier</p> <ul style="list-style-type: none"> • 60 and 72" wide tables have 2 sections. • 96" wide tables have 3 sections. • Tier: 24" deep x 10" high. 		30" x 48"		GLBDS-3048-__	3,026
		30" x 60"		GLBDS-3060-__	3,178
		30" x 72"	Please specify child 27" or adult 29"	GLBDS-3072-__	3,330
		36" x 48"		GLBDS-3648-__	3,177
		36" x 60"		GLBDS-3660-__	3,337
		36" x 72"		GLBDS-3672-__	3,496
		60" x 48"		GLBDS-6048-__	4,280
		60" x 52"		GLBDS-6052-__	4,493
		72" x 48"		GLBDS-7248-__	4,708
		72" x 52"		GLBDS-7252-__	4,922
	96" x 48"		GLBDS-9648-__	5,564	
	96" x 52"		GLBDS-9652-__	5,779	
 <p>Study Table Double-Sided, Single Tier with Shelf</p>		30" x 48"	Please specify child 27" or adult 29"	GLBST-3048-__	4,704
		30" x 60"		GLBST-3060-__	5,175

Options

- 033 – Grommet +\$55.
- 200 – Plastic laminate top, no additional charge
- G87 – Lumbercore top +10%

(Additional options, see back of book pages 70 – 71)

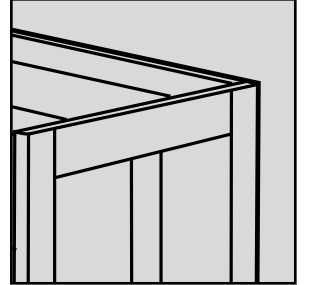

Ridge

arnoldkolax
Arnold Kolax Furniture, Inc.

End Panels

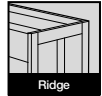

SINGLE-SIDED END PANELS

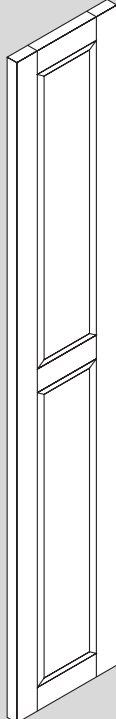
	Width	Ht.	Style Number	List Price	Options (see back of book)
 <p>Single-Sided End Panel</p> <ul style="list-style-type: none"> • 1" thick 	8" W	30"	GLRAX-308	\$374	G89 – 108" high +15% to 90" high price
		36"	GLRAX-368	382	
		42"	GLRAX-428	393	
		48"	GLRAX-488	419	
		60"	GLRAX-608	445	
		66"	GLRAX-668	461	
		72"	GLRAX-728	477	
		84"	GLRAX-848	504	
		90"	GLRAX-908	532	
	10" W	30"	GLRAX-3010	415	
		36"	GLRAX-3610	425	
		42"	GLRAX-4210	436	
		48"	GLRAX-4810	465	
		60"	GLRAX-6010	495	
		66"	GLRAX-6610	512	
		72"	GLRAX-7210	530	
		84"	GLRAX-8410	561	
		90"	GLRAX-9010	591	
	12" W	30"	GLRAX-3012	457	
		36"	GLRAX-3612	467	
		42"	GLRAX-4212	480	
		48"	GLRAX-4812	512	
		60"	GLRAX-6012	544	
		66"	GLRAX-6612	563	
		72"	GLRAX-7212	583	
		84"	GLRAX-8412	617	
		90"	GLRAX-9012	650	
	15" W	30"	GLRAX-3015	499	
		36"	GLRAX-3615	510	
		42"	GLRAX-4215	524	
		48"	GLRAX-4815	559	
		60"	GLRAX-6015	594	
		66"	GLRAX-6615	615	
72"		GLRAX-7215	636		
84"		GLRAX-8415	673		
90"		GLRAX-9015	710		
16" W	30"	GLRAX-3016	511		
	36"	GLRAX-3616	522		
	42"	GLRAX-4216	537		
	48"	GLRAX-4816	572		
	60"	GLRAX-6016	608		
	66"	GLRAX-6616	630		
	72"	GLRAX-7216	652		
	84"	GLRAX-8416	690		
	90"	GLRAX-9016	727		

Carrels

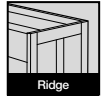

SINGLE UNITS

		Width	Depth	Ht.	Style Number	List Price
	Single-Faced Starter Carrel with Full End Panel	36"	31"	48"	GLRFCS-36	\$3,588
		48"	31"	48"	GLRFCS-48	3,658
	Single-Faced Add-On Carrel with Full End Panel	36"	31"	48"	GLRFCA-36	3,041
		48"	31"	48"	GLRFCA-48	3,113

DOUBLE UNITS

	Double-Faced Starter Carrel with Full End Panel	36"	62"	48"	GLRFDS-36	6,636
		48"	62"	48"	GLRFDS-48	6,778
	Double-Faced Add-On Carrel with Full End Panel	36"	62"	48"	GLRFDA-36	5,837
		48"	62"	48"	GLRFDA-48	5,874

Carrels

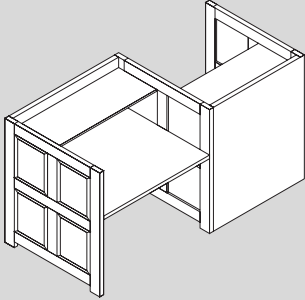
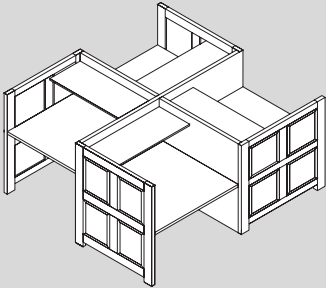

REVERSE & RADIATING UNITS

		Width	Depth	Ht.	Style Number	List Price
	Reverse Double Study Carrel	71"	31"	48"	GLRFCR-71	\$6,563
		95"	31"	48"	GLRFCR-95	6,706
	Radiating Quad Study Carrel	65"	65"	48"	GLRFCQ-65	12,711
		77"	77"	48"	GLRFCQ-77	12,889

Options

- 031 – Full articulating keyboard arm +\$458
- 033 – Grommet +\$55
- 036 – Black plastic cable raceway +\$8 per linear ft
- 036A – Black plastic cable raceway for a vertical surface +\$8 per linear ft
- 039 – Multi-outlet strip +\$65
- 200 – Plastic laminate worksurface, no additional charge
- 070 – Task light +\$308
- G90 – VDT package w/integrated suspension system +\$1320

(Additional options, see back of book pg. 70 – 71)

Occasional / Game Tables

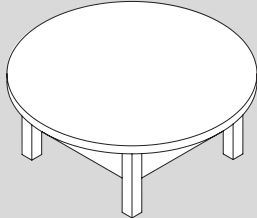
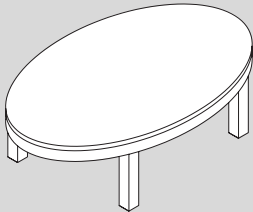
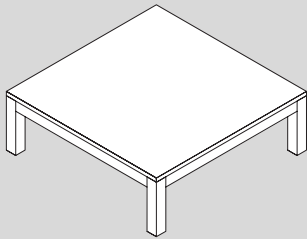
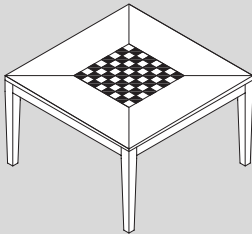
		Top Size (w x d)	Ht.	Style Number	List Price	Options (see back of book)
	Round Top • 1-3/4" squared post legs	24" dia.	16"	GLOT-24-__	\$746	G95 – Wood tapered leg + \$250 per table.
		30" dia.	16"	GLOT-30-__	828	
		36" dia.	16"	GLOT-36-__	986	
		42" dia.	16"	GLOT-42-__	1,177	
		48" dia.	16"	GLOT-48-__	1,287	
	Oval Top • 1-3/4" squared post legs	42" x 30"	16"	GLOT-4230-__	1,590	
		48" x 30"	16"	GLOT-4830-__	1,680	
		48" x 36"	16"	GLOT-4836-__	1,835	
	Square/ Rectangular Top • 1-3/4" squared post legs	24" x 24"	16"	GLOT-2424-__	546	
		30" x 18"	16"	GLOT-3018-__	497	
		30" x 30"	16"	GLOT-3030-__	628	
		36" x 18"	16"	GLOT-3618-__	513	
		36" x 36"	16"	GLOT-3636-__	786	
		42" x 18"	16"	GLOT-4218-__	531	
		42" x 42"	16"	GLOT-4242-__	977	
		48" x 18"	16"	GLOT-4818-__	632	
		48" x 48"	16"	GLOT-4848-__	1,087	
	Game Tables • Tapered Legs	36" sq.	29"	GLRTG-36-__	1,998	

Computer Utility Tables

Computer utility tables are created using standard Arnold Kolax Furniture library components. Below is a list of the components and a couple of examples for reference when specifying a computer utility table.

List of Components:

- Select end panel style (qty. 2) from Arnold Kolax Furniture library product lines. Common sizes: 24"/30" w x 30"/36"/42" h. See prices on pages 19, 27, 35, 43 and 59.
- Specify work counter length and depth. Arnold Kolax Furniture standard work counters are 24" or 30" deep, 1-1/4" thick surface (p-lam or wood veneer) and have a solid wood edge on one long side. All other edges are either p-lam self edge or wood veneer tape edge. See prices on page 13.
- Add support legs 1-1/4" thick. Arnold Kolax Furniture recommends one support leg per 48" open knee space. Support legs are available in several depths. Available depths are 12", 15", 20", 24" and 30". See prices on pages 26 and 27.
- Add optional 2" grommets. Cost +\$55. per grommet.
- Add optional 6" high divider/privacy panel. Cost + \$175. per panel.

Example A:

Universal Series Computer Utility Table

List of Components:

- (2) GLSDX-3024-B end panels 30" h x 24" d @ \$307. each = \$614. (See pricing on page 27.)
 - Work counter 192" l x 24" d @ 114 per ft. = \$1,824. (See pricing on page 13.)
 - (1) GLSDX-3024-B support panel 30" h x 24" d @ \$307. each = \$307. (See pricing on page 27.)
 - GLSAX-3015-B support panels 30" h x 15" d @159. each = \$636. (See pricing on page 26.)
 - (6) Option 033 2" grommets @ \$55. each = \$330
- Total Cost: \$3,711

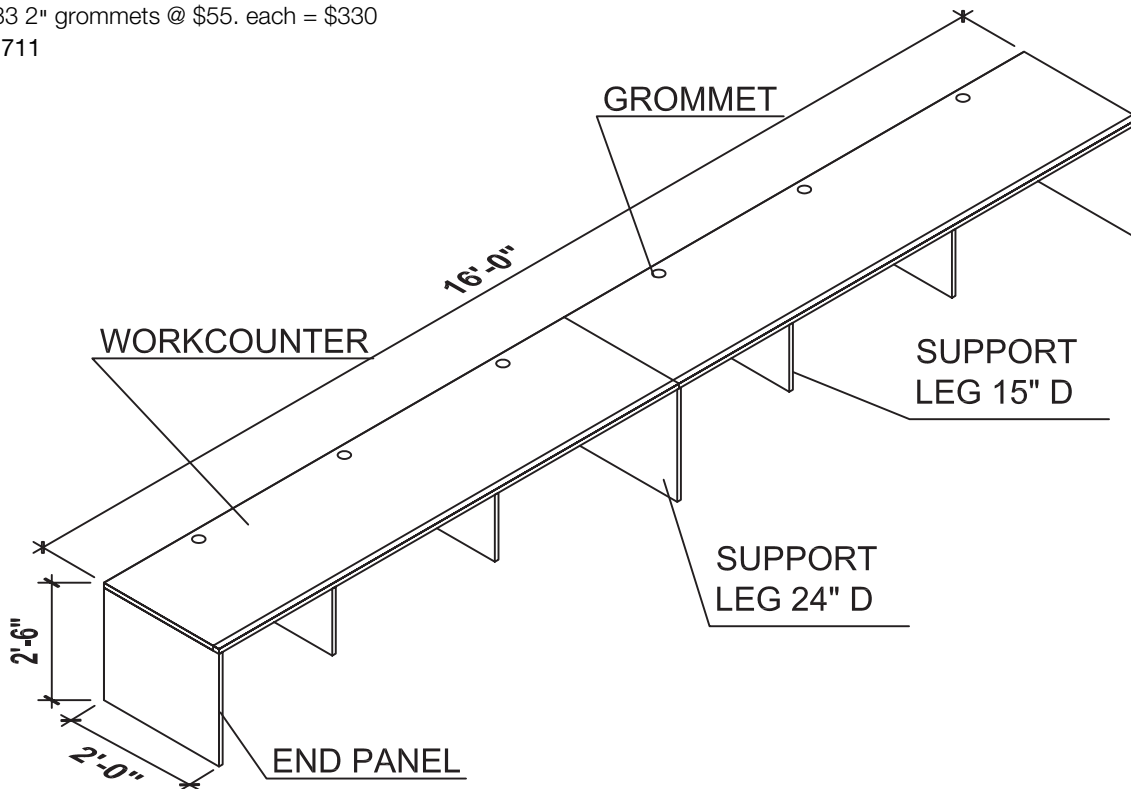

Computer Utility Tables

Example B:

Mountain Series Computer Utility Table

List of Components:

- a. (2) GLMDX-3630-B end panels 36" h x 30" d @ \$614. each = \$1,228. (See pricing on page 43.)
- b. Work counter 144" l x 30" d @ 122 per ft. = \$1,464. (See pricing on page 13.)
- c. (1) GLSDX-3030-B support panel 30" h x 30" d @ \$348. each = \$348. (See pricing on page 27.)
(2) GLSDX-3020-B support panels 30" h x 20" d @ \$279. each = \$558. (See pricing on page 26.)
- d. (4) Option 033 2" grommets @ \$55. each = \$220
- e. (3) 6" h divider/privacy panels @ \$175. each = \$525

Total Cost: \$4,343

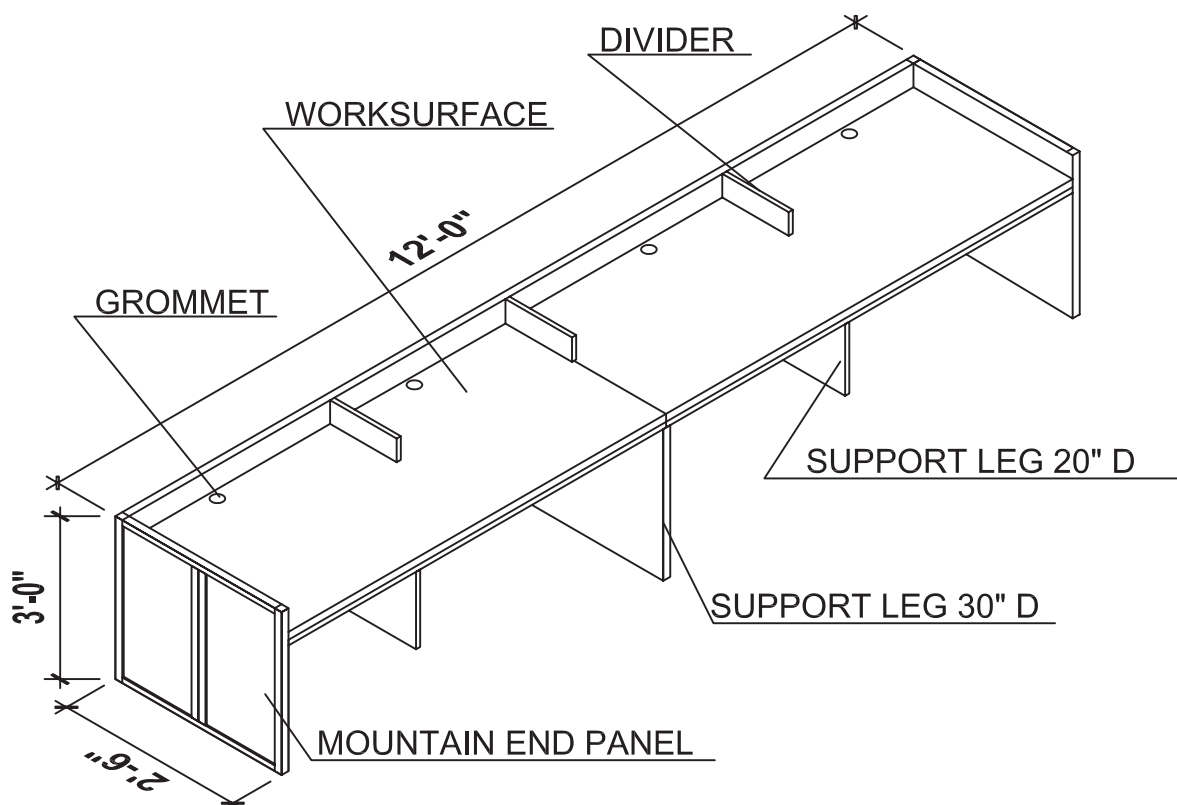

Modular Components

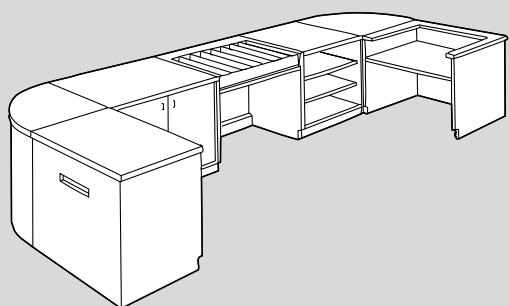

Arnold Kolax Circulation Desk Units are modular in design for the maximum in flexibility of arrangement. Units can be combined in virtually any configuration. When ordering please submit a plan of the arrangement intended. This will assist us in matching grain patterns on tops and fronts of units, which we will attempt to do as much as possible.

Please Note: Pacific/Mountain = 40% Upcharge
 Canyon = 50% Upcharge
 Ridge = 70% Upcharge

*Custom solutions are available. Please consult with factory.

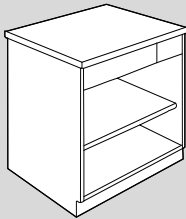
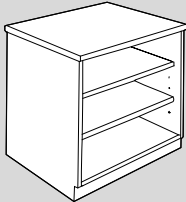
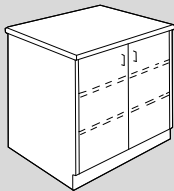
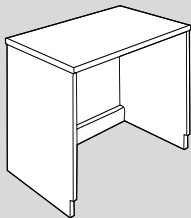
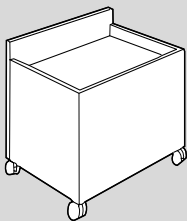
		Width x Depth	Ht.	Style Number	List Price	Ship Wt.	Options
	Charge Drawer Unit Inside depth: 24" 1 card file drawer, 1 box drawer, and 1 adjustable shelf.	36 x 27"	36"	GLCDU-36-__	\$2,598	200	
		36 x 27"	39"	GLCDU-39-__	2,610	210	
	Open Shelf Unit Inside depth: 24" 2 adjustable shelves.	36 x 27"	36"	GLOP-36-__	1,660	220	
		36 x 27"	39"	GLOP-39-__	2,022	230	
	Hinged Door Storage Unit Inside depth: 24" 2 adjustable shelves.	36 x 27"	36"	GLFD-36-__	1,898	245	Optional: Door lock + \$55. per pair of doors.
		36 x 27"	39"	GLFD-39-__	1,993	255	
	Book Return Unit Book slot on approach side. • 3" x 16" slot	36 x 27"	36"	GLBR-36-__	1,338	170	
		36 x 27"	39"	GLBR-39-__	1,350	180	
	Depressible Book Return Unit High pressure laminate depressible platform. Casters.	33 x 25"	36"	GLBRC-36-__	1,731	127	
		33 x 25"	39"	GLBRC-39-__	1,787	137	

Modular Components

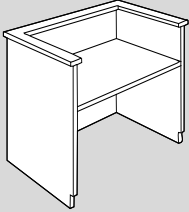
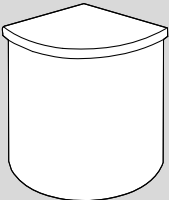
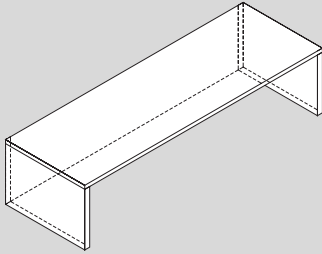
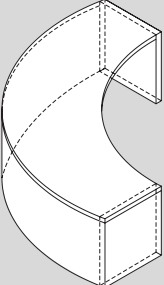
		Width x Depth	Ht.	Style Number	List Price	Ship Wt.
	Typing Desk Unit	36 x 27"	36"	GLTU-36-__	\$1,695	190
		36 x 27"	39"	GLTU-39-__	1,799	200
	Corner Unit Forms a 90° rounded corner.	27 x 27"	36"	GLCU-36-__	1,399	117
		27 x 27"	39"	GLCU-39-__	1,413	127
	Transaction Counter Rectangular	36 x 10"	12"	GLTCR-36	755	
	Transaction Counter Curved	27 x 10"	12"	GLTCR-27	1,075	

Circulation Desk Accessories

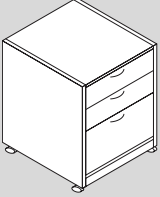
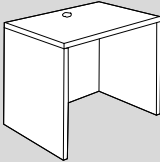
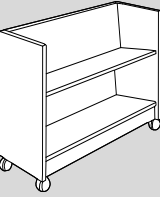
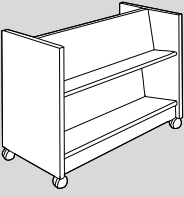
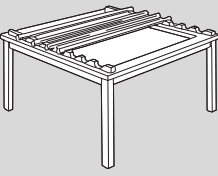
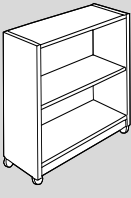
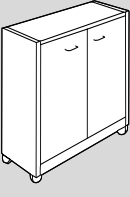
		Width x Depth	Ht.	Style Number	List Price	Ship Wt.	Options
	Mobile Unit 3 drawers. Casters.	16.75x18"	28"	GLMF-__	\$1,233	100	012 - Drawer lock + \$78 per pedestal.
	Computer Utility Table Grommet. No casters.	30 x 30" 36 x 30" 42 x 30" 54 x 30" 60 x 30" 72 x 30"	29" 29" 29" 29" 29" 29"	GLCU-30 GLCU-36 GLCU-42 GLCU-54 GLCU-60 GLCU-72	879 1,050 1,350 1,750 2,350 2,550	85 85 85 85 85 85	030 - Keyboard drawer + \$284
	Book Return Cart Single Sided Casters.	36 x 14"	28"	GLFBR-__	1,159	95	
	Book Return Cart Double Sided Casters.	36 x 18"	28"	GLFDBR-__	1,324	110	
	Newspaper Rack 10 wooden display rods.	40 x 26"	29"	GLNR-26-__	1,399	92	
	Mobile Open Bookcase 18" deep 1 adjustable shelf. Casters.	30"w	28"	GLMB-__	899	85	
	Mobile Storage Unit 18" deep Casters.	30"w	28"	GLMS-__	1,057	92	010 - Door Lock + \$55 per pair doors.

Circulation Desk Accessories

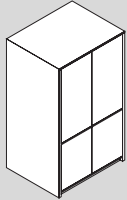
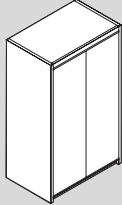
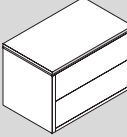
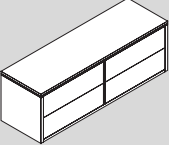
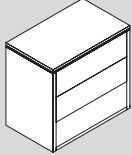
		Width	Ht.	Shelves	Style Number	List Price	Ship Wt.	Options
	Audio/Video Cabinet 24" deep	30" W	60"		GLCRTC-6030	\$3,700		
			72"		GLCRTC-7230	4,000		
			84"		GLCRTC-8430	4,500		
	• Pull-out shelf and retractable doors in upper section. • Pull-out shelf in lower section.	36" W	60"		GLCRTC-6036	3,775		
			72"		GLCRTC-7236	4,100		
			84"		GLCRTC-8436	4,625		
	Storage Cabinet 19" deep	30" W	29"	1	GLWD-2930	1,250		
			60"	3	GLWD-6030	1,800		
			72"	4	GLWD-7230	1,925		
			84"	5	GLWD-8430	2,100		
	• Cabinet with full wood doors.	36" W	29"	1	GLWD-2936	1,375		
			60"	3	GLWD-6036	1,925		
72"			4	GLWD-7236	2,075			
84"			5	GLWD-8436	2,250			
	File Credenza 19" deep	30" W	29"		GLFC-30	600		
		36" W	29"		GLFC-36	700		
• 2 lateral file drawers.								
	File Credenza 19" deep	60" W	29"		GLFC-60	1,200		
		72" W	29"		GLFC-72	1,350		
• 4 lateral file drawers.								
	File Credenza 19" deep	30" W	29"		GLFCH-30	900		
		36" W	29"		GLFCH-36	1,050		
• 3 lateral file drawers.								

Options

Locks

- 010** - Door lock + \$66. for each pair of doors.
- 011** - Door lock + \$66. for each individual door.
- 012** - Drawer lock + \$86. per pedestal.
- 013** - Center drawer lock + \$40.
Lock for center drawer on desks.

Drawers and Pedestals

- 020** - Center drawer for desk + \$184.
22" wide.

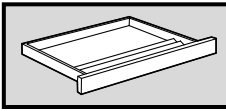

- 021** - File/file pedestal instead of B/B/F. No additional charge.
- 022** - Horizontal wood finger pulls + \$78. per drawer.

- 030** - Pull-out keyboard drawer + \$342. Inside dimensions: 22" W x 12" D x 2" H. Available for conference tables, desk height returns (48" or longer), writing credenzas, and storage units.

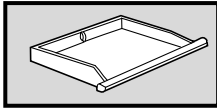

Selected Power & Data Solutions

- 142** - Retractable Power & Communications Center + \$350 and up. Retractable Power, Data, and Voice grommet. Molded plastic unit with pull up access. Available in seven cap finishes. UL listed and CSA approved. Size is 5.375" W x 4.125" D x 7.5" H when pulled up. **Standard Items:** Three power receptacles, 120" power cord with molded plug. **Optional Items:** RJ11 Voice Cat3, RJ45 Data Cat5, hardwiring of power and longer power cords. Call factory for pricing on these options if not listed below.

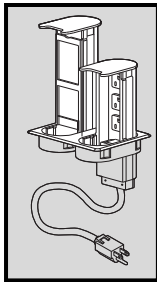

	Data	Voice	Video	List Each
142-A	1	1	0	\$386
142-B	2	1	1	408
142-C	4	0	0	419

For Grey, Neutral, Translucent, Nickel Mica, Silver Mica, or Charcoal Mica cap finish add \$40. For a hardwired unit please add \$45.

- 143** - Retractable Power Center + \$275. Retractable Power, grommet. Molded plastic unit with pull up access. Available in seven cap finishes.

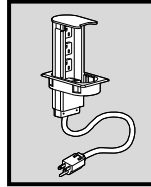

UL listed and CSA approved. Size is 2.625" W x 4.125" D x 5.125" H when pulled up. **Standard Items:** Three power receptacles, 120" power cord with molded plug. **Optional Items:** Hardwiring of power and longer power cords. Call factory for pricing on this option if not listed below.

	Data	Voice	Video	List Each
143-A	N/A	N/A	N/A	\$304

For Grey, Neutral, Translucent, Nickel Mica, Silver Mica, or Charcoal Mica cap finish add \$40. For a hardwired unit please add \$45. Please also see Option #142 for similar unit *with* power, data and voice capabilities.

- 144** - UDT3/VD Under Table P/D/V Grommet + \$300 and up. Under table mount Power, Data, and Voice grommet. Fixed metal unit can be installed in lecterns or table support aprons. Size is 9" W x 2.5" H x 2" D. Made in the U.S.A. If mounted in FQ table edge the edge thickness will be increased to 3.75" at no upcharge. Corded unit with plug is UL listed. **Standard Items:** Three power receptacles, 144" power cord with molded plug. **Optional Items:** RJ11 Voice Cat3, RJ45 Data Cat6, 15 Pin HD Video, longer power cords up to 15' and many more. Call factory for pricing on these options if not listed below.

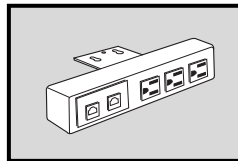

	Data	Voice	Video	List Each
144A	1	1	0	\$330
144B	2	1	0	362
144C	3	0	0	372
144D	1	0	1	364
144E	2	0	1	380

For Hardwire ready unit with 144" metal flex whip please add \$65.

- 147** - Power Column + \$180. Black angular with 15 amp rating and circuit breaker. There are two plugs above the worksurface and one below.

Can be mounted into any 90° corner. Power/Data Column + \$255.

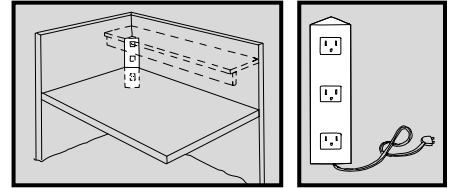

- 167** - Angled Top Notch Power & Data Grommet + \$270. Fixed power and data grommet for the individual. Ideal for lecterns, conference tables, training tables, study carrels, and desks. Available in two finishes. Size is 3.67" W x 3.5" D x 1.24" H above surface. Unit is neither UL listed nor CSA approved. **Standard Items:** One power receptacle with 144" cord with molded plug. **Optional Items:** RJ11 Voice Cat3 with 144" patch cable, RJ45 Data Cat6 with 144" patch cable, and longer power cords.

	Data	Voice	Video	List Each
167A	1	0	N/A	\$298
167B	0	1	N/A	298

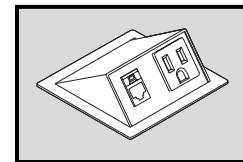

*For additional options, please refer to Arnold Kolax Furniture Power/Data Options Price List.

Options

Computer & Electrical Equipment

033 - 2" diameter grommet with cap. *Please order by complete model number below. If no model number is given #033-A will be supplied.*

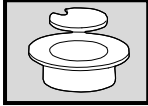

033-A*	Black Plastic	+ \$55.
033-B	Matte Black Metal	+ \$110.
033-C	Polished Chrome	+ \$110.
033-D	Satin Chrome	+ \$110.
033-E	Polished Brass	+ \$120.
033-F	Antique Brass	+ \$120.
033-G	Satin Nickel	+ \$120.

*Due to slight variances in grommet hole size, a plastic grommet cannot be swapped for a metal grommet after the hole has been cut and vice-versa.

036 - Plastic cable raceway + \$8 per linear foot 1.5 x 1". Ideal for managing computer and electric wires. Can be attached to any surface with double-faced tape.

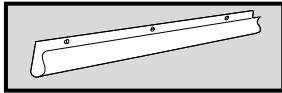
**Selected Keyboard Tray Solutions**

031 - Full articulating keyboard arm + \$458. Available for any 21" deep desk high surface. Comes with wrist rest and swing out mouse pad. Swivels side to side and tilts toward user. Mouse pad may be mounted on left or right.

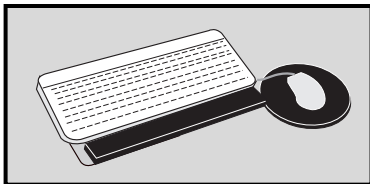
**Finishes: Optional & Special**

200 - Plastic laminate top. No additional charge
Your choice of Nevamar, Formica, Pionite or WilsonArt.

201 - Color match + \$83., net minimum or 15% per match.

202 - Gloss plastic laminate top + 10%.

Circulation Desk Accessories

070 - Task light with facia + \$309.

071 - Cork tackboard + \$32 per square foot.

072 - Fabric tackboard + \$45 per square foot.
Grey Mix #238, Wheat #130, or Black #408

For additional power/data options, please refer to the Arnold Kolax Furniture Power & Data Options Price Guide.

Dock Delivery Price List

For Arnold Kolax Furniture

ORDERS OVER \$25,000 LIST CALL THE FACTORY

ZONE ONE

NORTHERN NEW JERSEY,
MANHATTAN, BRONX, QUEENS,
STATEN ISLAND & BROOKLYN

**3.5% OF FURNITURE LIST PRICE
IS THE NET FREIGHT COST**
MINIMUM \$125

ZONE TWO

FAIRFIELD, CT.
WESTCHESTER, ROCKLAND,
NASSAU COUNTIES, NY,
SUFFOLK COUNTY,
SOUTHERN NEW JERSEY

**4% OF FURNITURE LIST PRICE
IS THE NET FREIGHT COST**
MINIMUM \$175

ZONE THREE

NEW HAVEN, HARTFORD, CT,
PHILADELPHIA & PA EAST OF HARRISBURG

**5% OF FURNITURE LIST PRICE
IS THE NET FREIGHT COST**
MINIMUM \$190

ZONE FOUR

RHODE ISLAND,
PA WEST OF HARRISBURG,
UPSTATE NEW YORK, DELAWARE, MARYLAND
WASHINGTON DC, BOSTON &
MASSACHUSETTS

**5.5% OF FURNITURE LIST PRICE
IS THE NET FREIGHT COST**
MINIMUM \$225

**FOR DESTINATIONS NOT SHOWN
OR FOR INSIDE DELIVERY AND INSTALLATIONS
PLEASE CALL FACTORY**

Prices shown above represent non-union, straight time delivery.

Crating charges are included in the price.

Product may arrive blanket wrapped or crated.

It is the customers responsibility to make sure that furniture can fit in building and elevator.

Allow 6-8 days additional to acknowledged shipping date for delivery.

Upcharges will be assessed for the following:

- overtime delivery
- union requirements
- carry-up of furniture
- moving of existing furniture
- attempted delivery
- masonite coverage on floors
- disassembly of furniture for narrow doorways or elevators
- special insurance requirements
- over-sized desk (wider than 96")

Due to the uncertainty of energy prices a fuel surcharge may be applicable. Please check our web site for up to date freight information.

Phone 973-375-3344
Toll Free 866-425-6529
Fax 973-375-6024
arnoldkolax.com

arnoldkolax

Arnold Kolax Furniture, Inc.

Arnold Kolax Furniture, Inc.
609 Chancellor Avenue • Irvington, NJ 07111