

Georgetown features: Traditional details semi-circular counter with 2" th ogee edge, flat angled panels with applied picture frame molding, and solid wood plinth base.
Available in receptionist and executive heights

Plan Configurations	Sizes WxDxH	Model No.	Price	Ship Wt
Configuration 0 Desk only, with grommet	EXECUTIVE HEIGHT			
	84x42x30	RGD_0842	\$14,554	450
	96x48x30	RGD_0962	\$16,312	550
	INSIDE/OUTSIDE OVERHANG			
	84x42x42	RGC_0842	\$18,874	600
	96x48x42	RGC_0962	\$20,765	700

Desk only, 42"d x 42"h with grommet.
See storage options below.

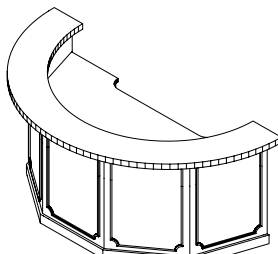

Plan Configurations	Sizes WxDxH	Model No.	Price	Ship Wt
Configuration 1 Desk with Return	EXECUTIVE HEIGHT			
	84x90x30	RGD_1842	\$20,279	750
	96x96x30	RGD_1962	\$22,050	850
	INSIDE/OUTSIDE OVERHANG			
	84x90x42	RGC_1842	\$24,901	850
	96x96x42	RGC_1962	\$27,508	950

Desk and 42" w x 21" d return, with two grommets.
See storage options below.
Specify left or right return.

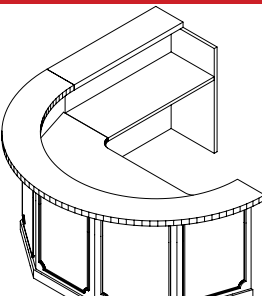

Plan Configurations	Sizes WxDxH	Model No.	Price	Ship Wt
Configuration 2 Desk with Bridge and Credenza	EXECUTIVE HEIGHT			
	84x110x30	RGD_2842	\$27,122	700
	96x116x30	RGD_2842	\$30,309	800
	INSIDE/OUTSIDE OVERHANG			
	84x110x42	RGC_2842	\$31,416	700
	96x116x42	RGC_2962	\$33,612	800

Desk, 48" w x 21" d bridge and 20" d rear credenza shell, with three grommets.
See storage options below.
Specify left or right return.

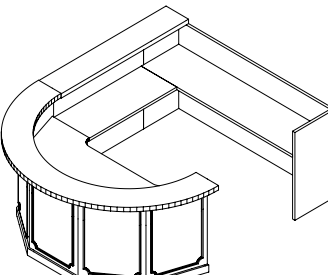

Edge details for transaction counter tops. 2" thick

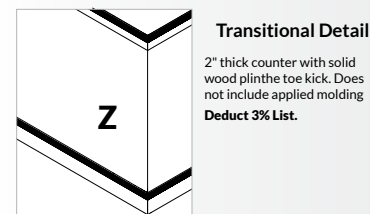
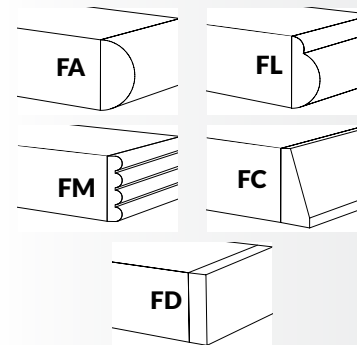

Options:

- 3" high chrome, brass or black base:
- Marble/granite inlay on transaction countertop or glass on stand offs.

Please call factory for pricing

Storage options to be placed under worksurface

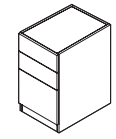
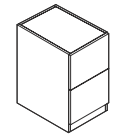
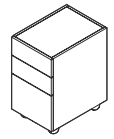
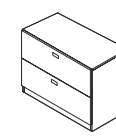
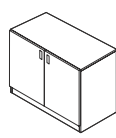
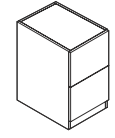
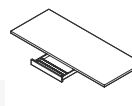
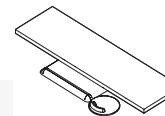
<p>RPED 21 Box, box, file pedestal with lock, 16" wide. Add \$1,929 List.</p> 	<p>RPED 02 File, file pedestal with lock, 16" wide. Add \$1,740 List.</p> 	<p>RMP 21 Mobile BBF pedestal, with lock, 16" wide. Add \$2,272 List.</p> 	<p>RFL 30 - RFL 36 Lateral file with lock, 30" or 36" wide. Add \$2,613 List.</p> 
<p>RDC 30 2-door storage with adj wood shelf, 30" wide. Add \$2,120 List.</p> 	<p>RDC 60 4-door storage with adj wood shelves, 60" wide. Add \$2,730 List.</p> 	<p>020 Pencil drawer Add \$349 List.</p> 	<p>031 Articulating Keyboard drawer Add \$855 List.</p> 

Prices shown are list prices - FOB Factory